



Revision A:

• MS-GF50VA- , MS-GF60VA-  and MS-GF80VA-  have been added.

Please void OBH621.

INDOOR UNIT SERVICE MANUAL

No. OBH621
REVISED EDITION-A

Models

MS-GF20VA - 
MS-GF25VA - 
MS-GF35VA - 
MS-GF50VA - 
MS-GF60VA - 
MS-GF80VA - 

Outdoor unit service manual
MU-GF·VA Series (OBH622)

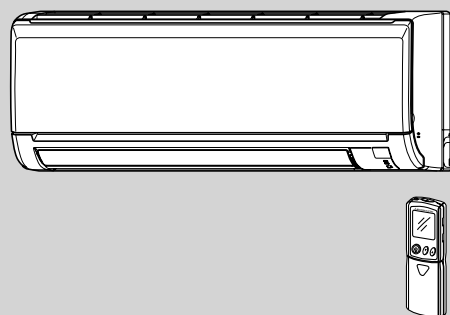

CONTENTS

1. TECHNICAL CHANGES	2...
2. PART NAMES AND FUNCTIONS	3·
3. SPECIFICATION	5.....
4. NOISE CRITERIA CURVES	6··
5. OUTLINES AND DIMENSIONS	8·
6. WIRING DIAGRAM	9.....
7. REFRIGERANT SYSTEM DIAGRAM	10
8. SERVICE FUNCTIONS	12·
9. MICROPROCESSOR CONTROL	14
10. TROUBLESHOOTING	21··
11. DISASSEMBLY INSTRUCTIONS	35

PARTS CATALOG (OBB621)

NOTE:

RoHS compliant products have <G> mark on the spec name plate.



Use the specified refrigerant only

Never use any refrigerant other than that specified.

Doing so may cause a burst, an explosion, or fire when the unit is being used, serviced, or disposed of.

Correct refrigerant is specified in the manuals and on the spec labels provided with our products.

We will not be held responsible for mechanical failure, system malfunction, unit breakdown or accidents caused by failure to follow the instructions.

<Preparation before the repair service>

- Prepare the proper tools.
- Prepare the proper protectors.
- Provide adequate ventilation.
- After stopping the operation of the air conditioner, turn off the power-supply breaker and remove the power plug.
- Discharge the capacitor before the work involving the electric parts.

<Precautions during the repair service>

- Do not perform the work involving the electric parts with wet hands.
- Do not pour water into the electric parts.
- Do not touch the refrigerant.
- Do not touch the hot or cold areas in the refrigeration cycle.
- When the repair or the inspection of the circuit needs to be done without turning off the power, exercise great caution not to touch the live parts.

Revision A:

- MS-GF50VA- [E1], MS-GF60VA- [E1] and MS-GF80VA- [E1] have been added.

1

TECHNICAL CHANGES

MS-GF20VA - [E1]

MS-GF25VA - [E1]

MS-GF35VA - [E1]

1. New model

MS-GF50VA - [E1]

MS-GF60VA - [E1]

MS-GF80VA - [E1]

1. New model

2

PART NAMES AND FUNCTIONS

MS-GF20VA MS-GF25VA MS-GF35VA

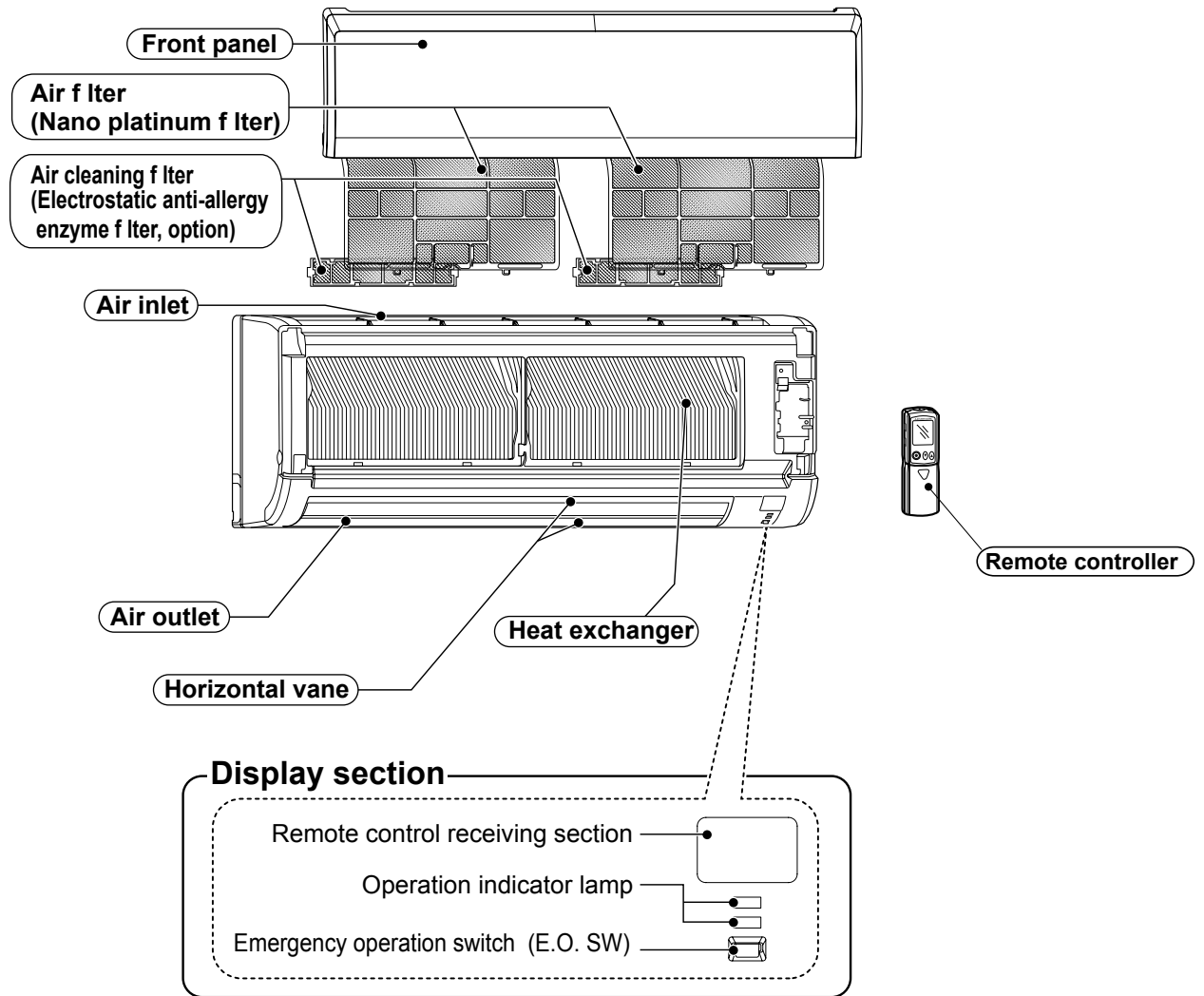

ACCESSORIES

Model	MS-GF20VA MS-GF25VA MS-GF35VA
① Installation plate	1
② Installation plate fixing screw 4 × 25 mm	5
③ Remote controller holder	1
④ Fixing screw for ③ 3.5 × 16 mm (Black)	2
⑤ Battery (AAA) for remote controller	2
⑥ Wireless remote controller	1
⑦ Felt tape (For left or left-rear piping)	1

MS-GF50VA MS-GF60VA MS-GF80VA

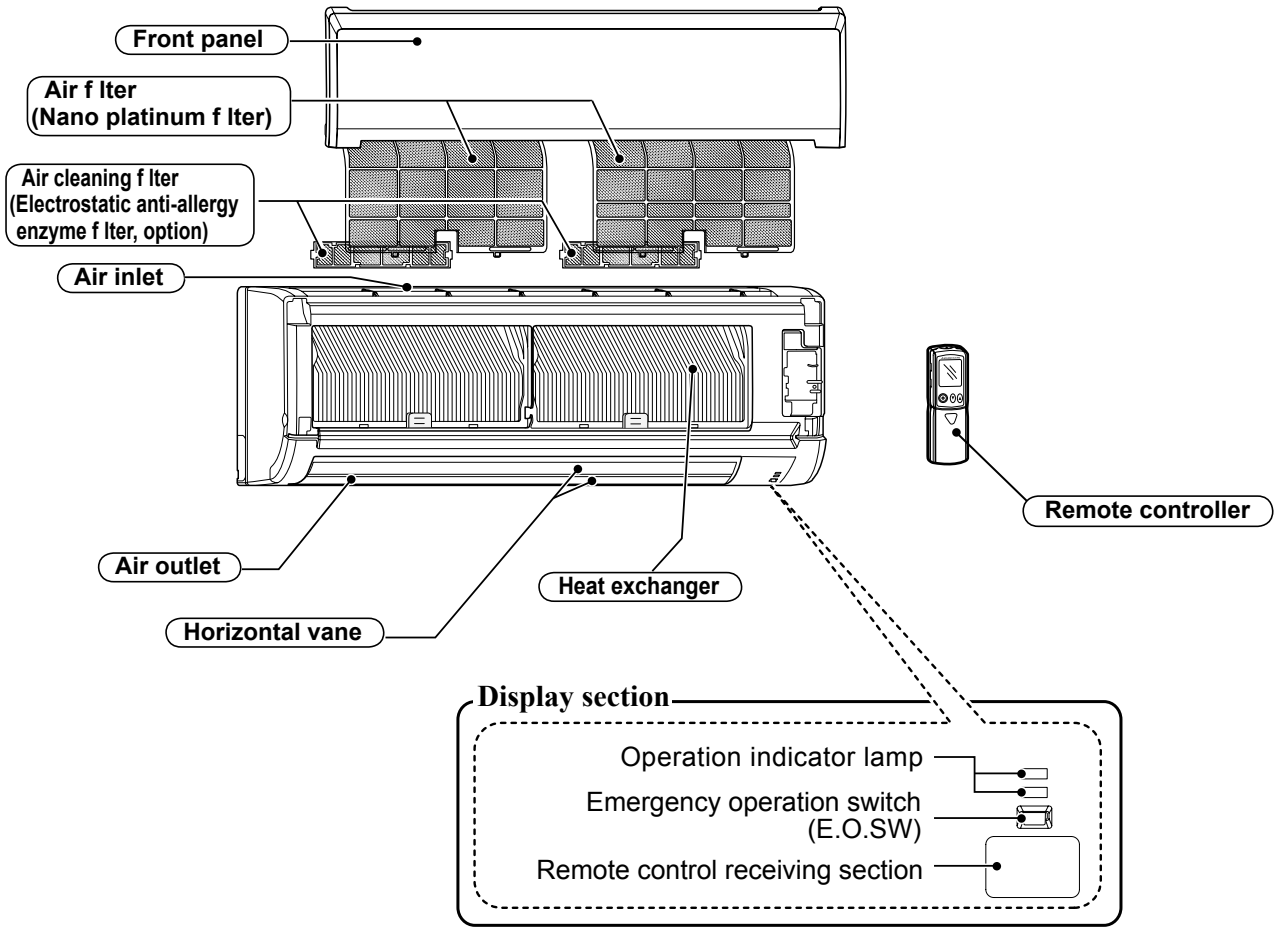

ACCESSORIES

Model	MS-GF50VA MS-GF60VA MS-GF80VA
① Installation plate	1
② Installation plate fixing screw 4 × 25 mm	7
③ Remote controller holder	1
④ Fixing screw for ③ 3.5 × 16 mm (Black)	2
⑤ Battery (AAA) for remote controller	2
⑥ Wireless remote controller	1
⑦ Felt tape (For left or left-rear piping)	1

3

SPECIFICATION

Indoor model			MS-GF20VA	MS-GF25VA	MS-GF35VA	MS-GF50VA	MS-GF60VA	MS-GF80VA
Function			Cooling					
Power supply			Single phase 230 V, 50 Hz					
Electrical data	Running current	A	0.20	0.22	0.30	0.42		
	Power input	W	35	43	39	51		
Fan motor	Model		RC4V18-FA			RC0J56-AF		
	Current	A	0.20	0.22	0.30	0.42		
Dimensions W × H × D		mm	798 x 295 x 232			1,100 x 325 x 238		
Weight		kg	9			16		
Special remarks	Air direction		5					
	Air flow	Super High (POWERFUL)	m ³ /h	558	624	1,086	1,086	1,206
		High		474	558	870	942	1,086
		Med.		378	396	762	822	978
		Low		246	288	642	714	882
	Sound level	Super High (POWERFUL)	dB (A)	40	44	45	48	50
		High		36	40	42	45	47
		Med.		31	33	38	41	43
		Low		25	26	34	37	39
	Fan speed	Super High (POWERFUL)	rpm	1,000	1,100	1,100	1,100	1,200
		High		880	1,000	920	980	1,100
		Med.		740	770	800	880	1,010
		Low		540	610	720	790	930
Fan speed regulator			4					
Remote controller model			KM12A			KM12B		

NOTE: Test conditions are based on ISO 5151.

Cooling: Indoor Dry-bulb temperature 27 °C Wet-bulb temperature 19 °C

Outdoor Dry-bulb temperature 35 °C Wet-bulb temperature 24 °C

Indoor-Outdoor piping length: 5 m

4

NOISE CRITERIA CURVES

MS-GF20VA

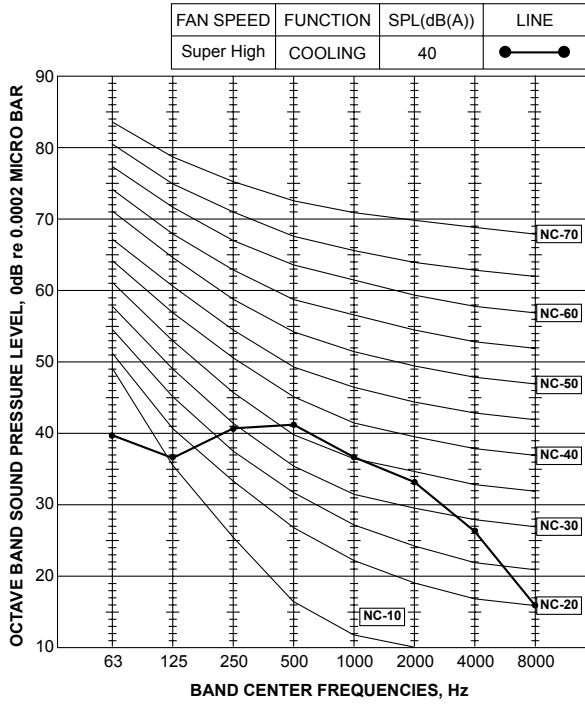

MS-GF25VA

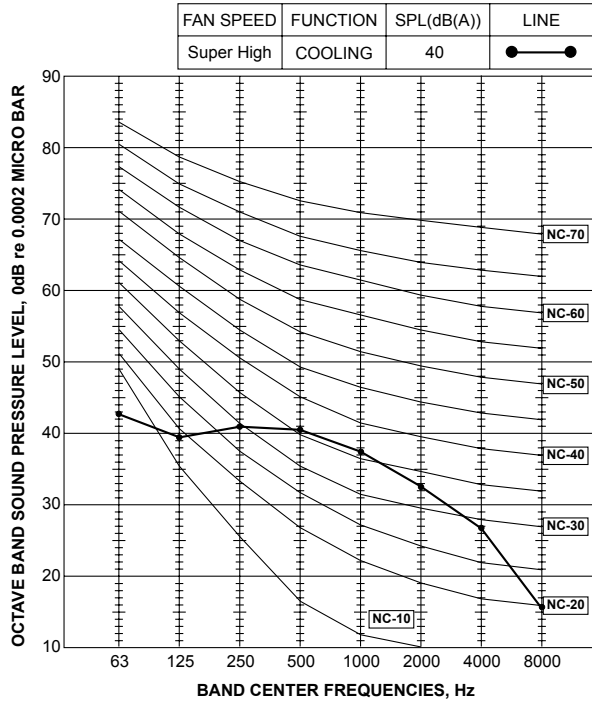

MS-GF35VA

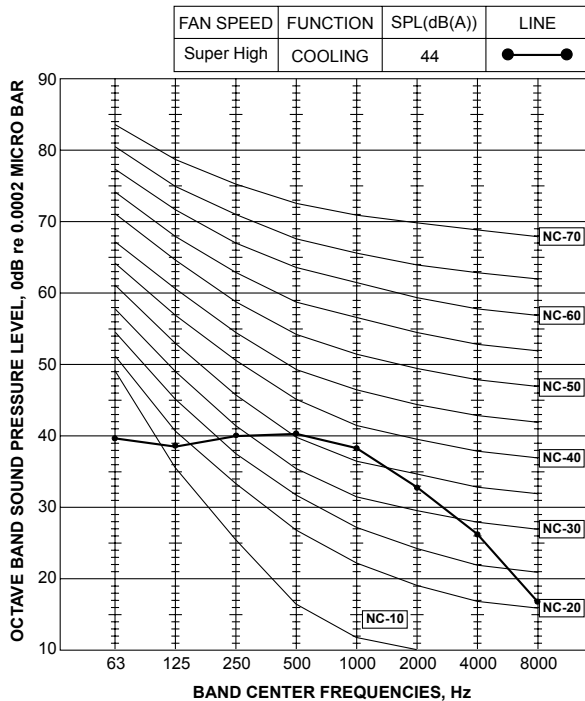

Test conditions

Cooling: Dry-bulb temperature 27 °C
Wet-bulb temperature 19 °C

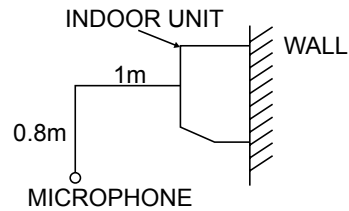

MS-GF50VA

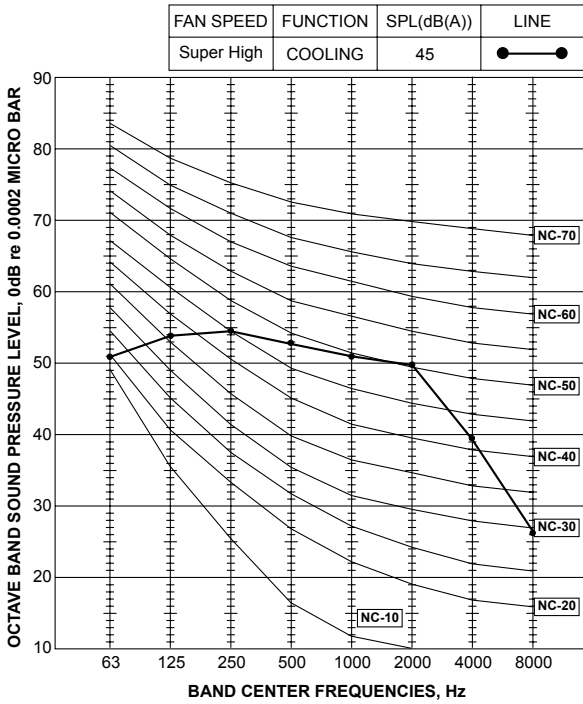

MS-GF60VA

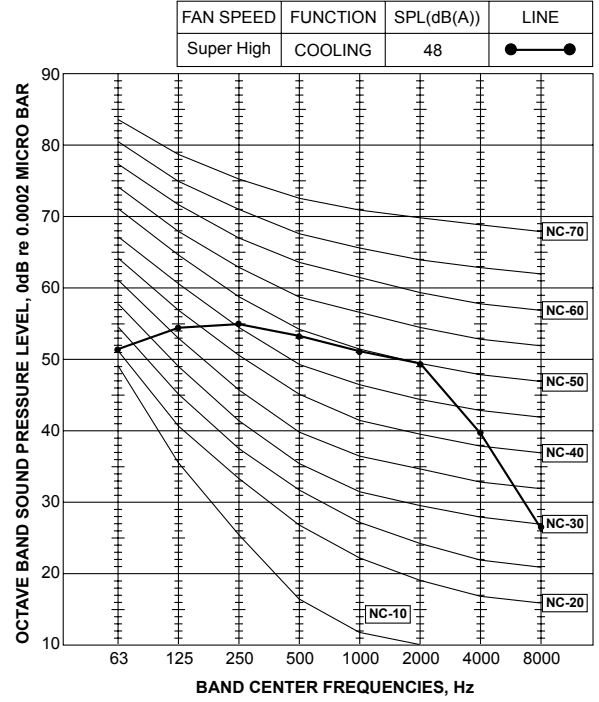

MS-GF80VA

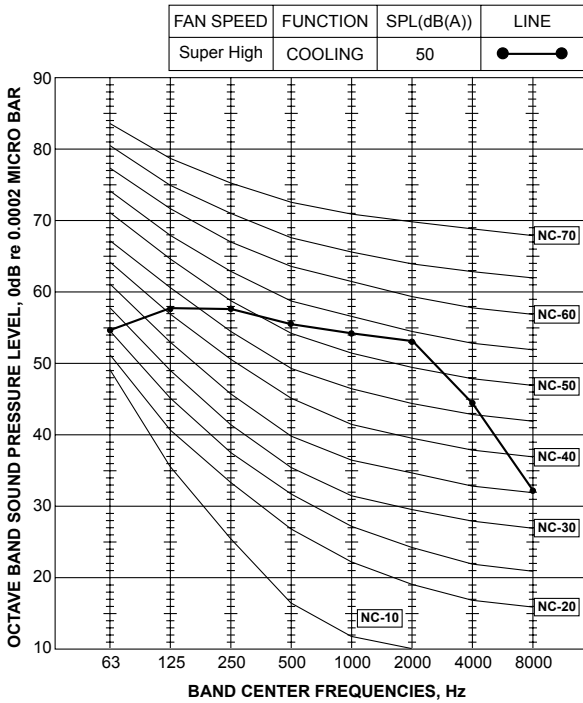

5

OUTLINES AND DIMENSIONS

MS-GF20VA MS-GF25VA MS-GF35VA

Unit: mm

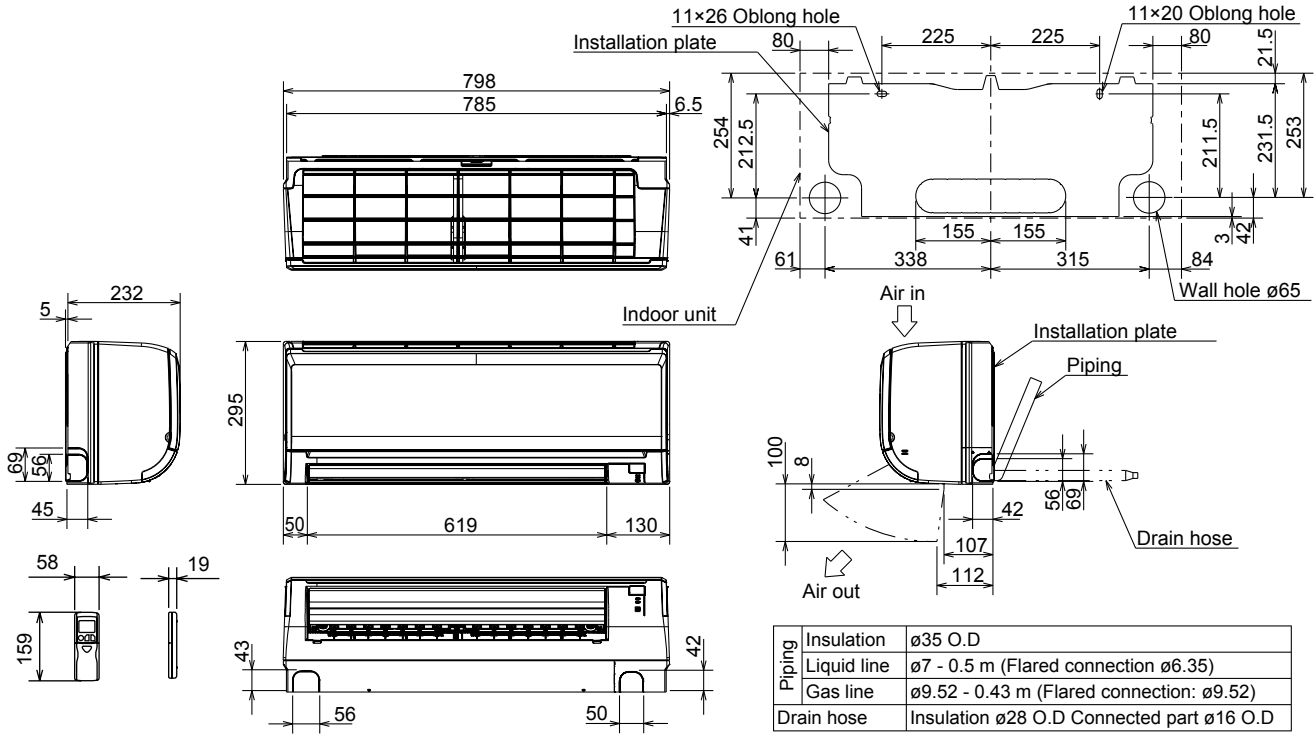

MS-GF50VA MS-GF60VA MS-GF80VA

Unit: mm

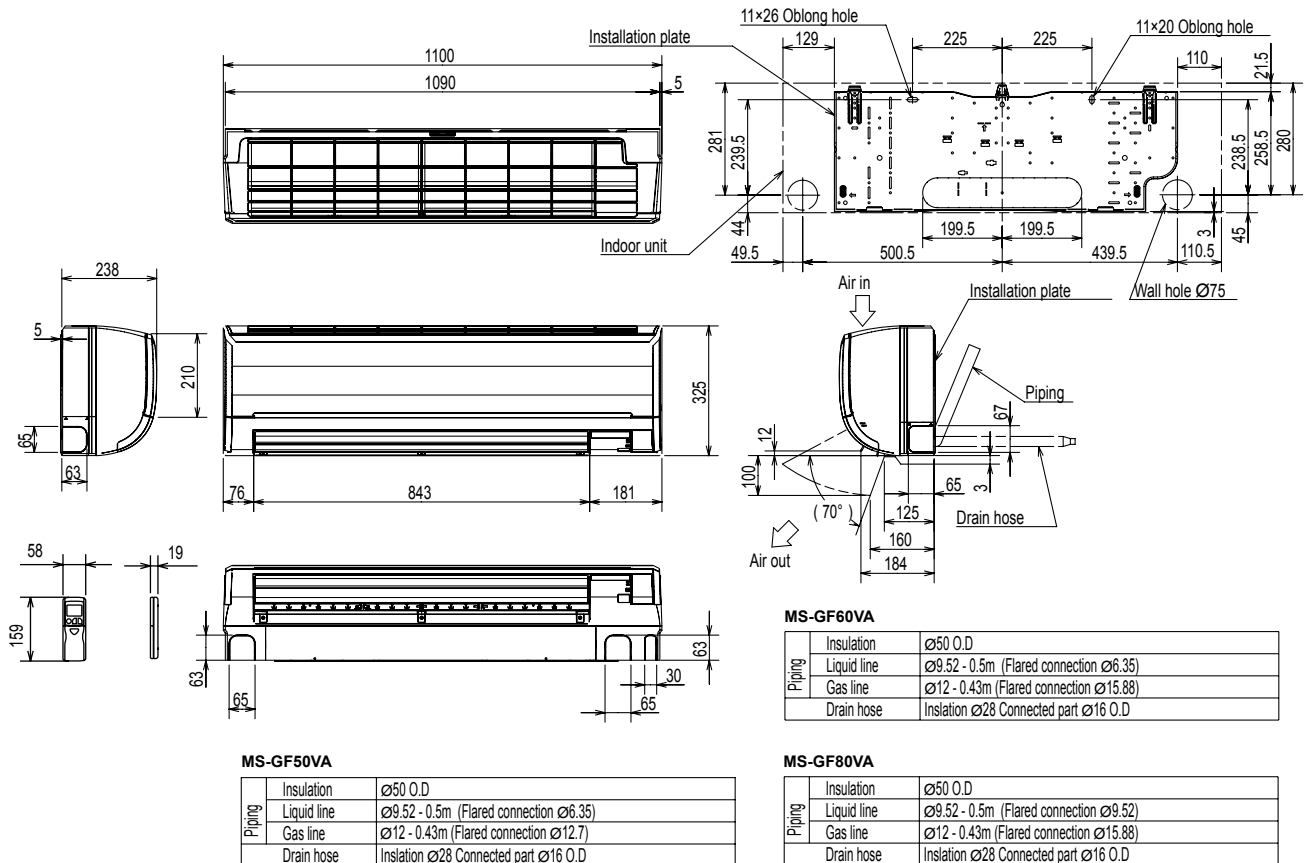

6

WIRING DIAGRAM

MS-GF20VA MS-GF25VA MS-GF35VA

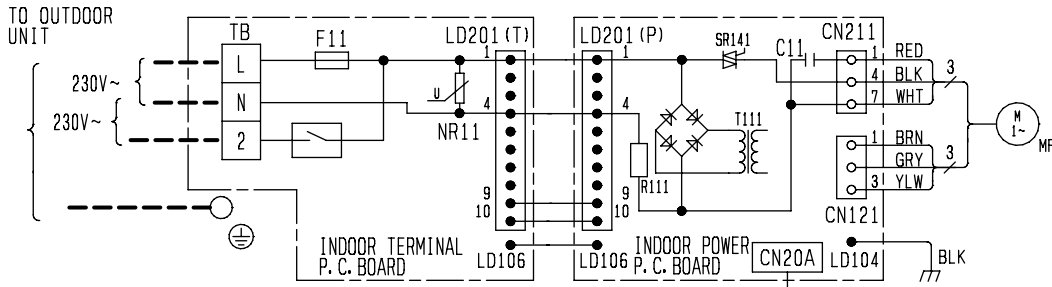

SYMBOL	NAME
C11	FAN MOTOR CAPACITOR
F11	FUSE (T3. 15A/250V)
MF	FAN MOTOR (INNER FUSE)
MV	VANE MOTOR (HORIZONTAL)
NR11	VARISTOR
R111	RESISTOR
RT11	ROOM TEMP. THERMISTOR
RT12	COIL TEMP. THERMISTOR
SR141	SOLID STATE RELAY
TB	TERMINAL BLOCK
T111	TRANSFORMER

- NOTES: 1. About the outdoor side electric wiring refer to the outdoor unit electric wiring diagram for servicing.
 2. Use copper conductors only. (For field wiring)
 3. Symbols indicate.

□ : Terminal block
 ⊞ : Connector

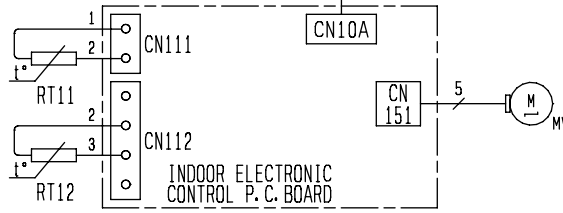

MS-GF50VA MS-GF60VA MS-GF80VA

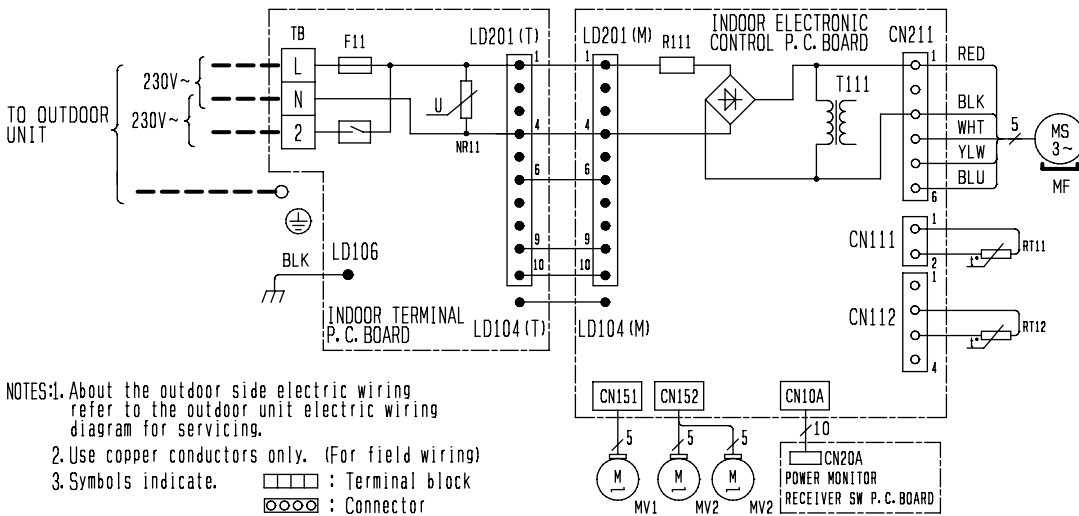

SYMBOL	NAME
F11	FUSE (T3. 15A/250V)
MF	FAN MOTOR
MV1	VANE MOTOR (HORIZONTAL)
MV2	VANE MOTOR (VERTICAL)
NR11	VARISTOR
R111	RESISTOR
RT11	ROOM TEMP. THERMISTOR
RT12	COIL TEMP. THERMISTOR
T111	TRANSFORMER
TB	TERMINAL BLOCK

- NOTES: 1. About the outdoor side electric wiring refer to the outdoor unit electric wiring diagram for servicing.
 2. Use copper conductors only. (For field wiring)
 3. Symbols indicate.

□ : Terminal block
 ⊞ : Connector

7

REFRIGERANT SYSTEM DIAGRAM

MS-GF20VA MS-GF25VA

Unit: mm

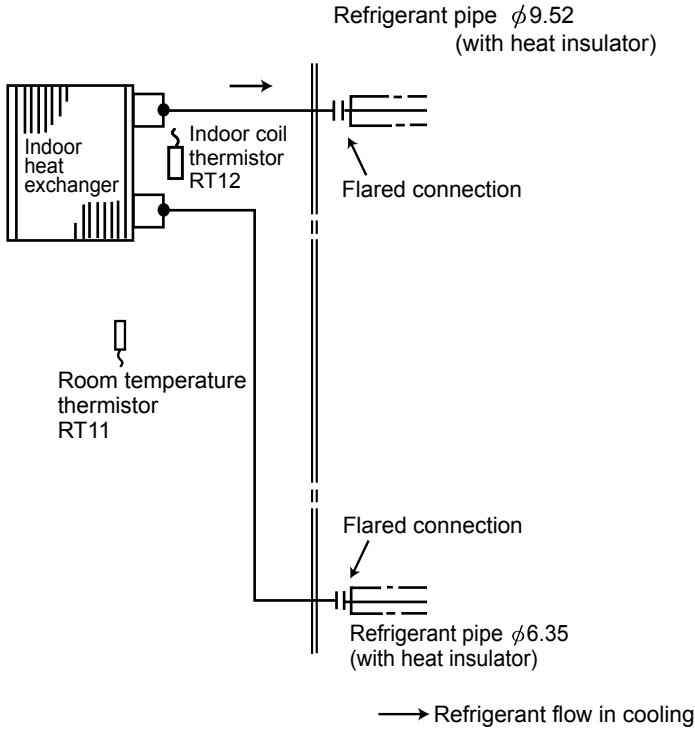

MS-GF35VA

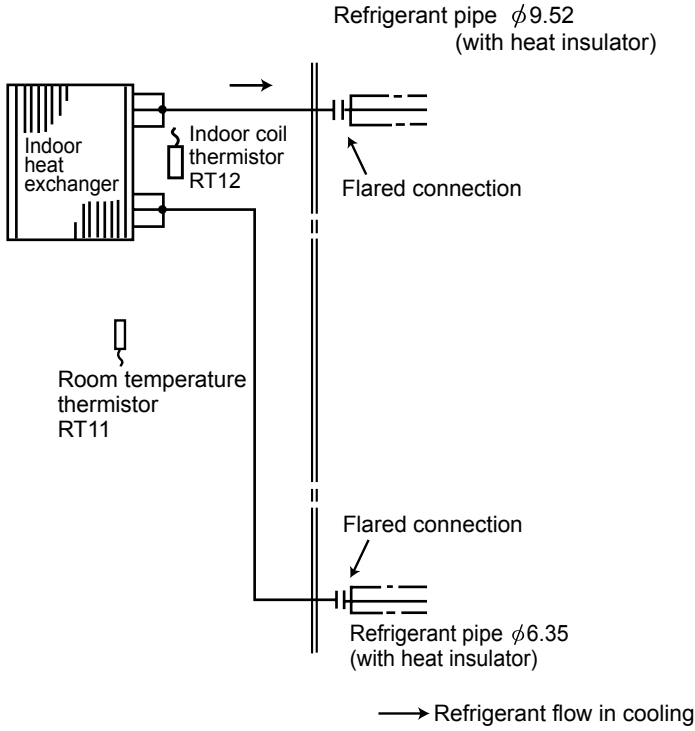



MS-GF50VA MS-GF60VA MS-GF80VA

Unit: mm

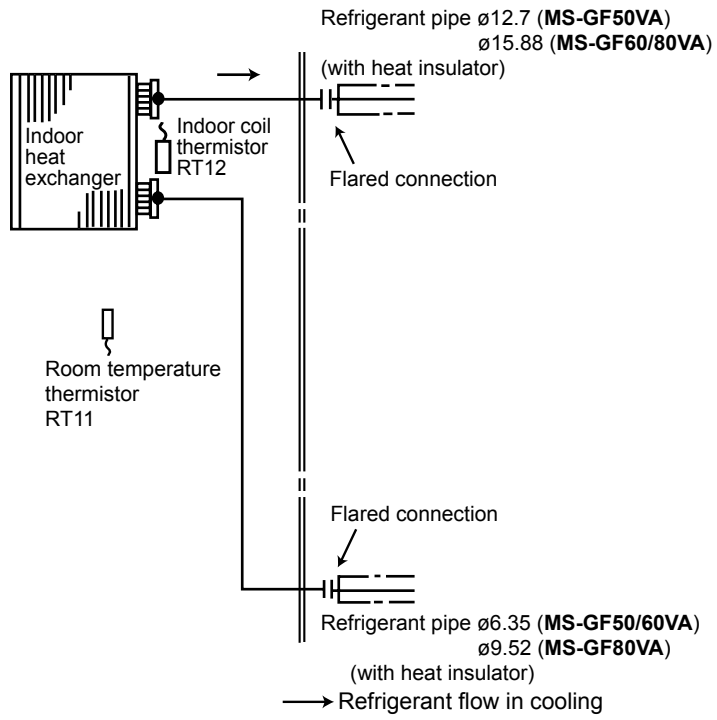

MS-GF20VA MS-GF25VA MS-GF35VA MS-GF50VA MS-GF60VA MS-GF80VA**8-1. TIMER SHORT MODE**

For service, the following set time can be shortened by short circuit of JPG and JPS on the electronic control P.C. board. (Refer to 10-7.)

Set time: 3 minutes → 3 seconds (It takes 3 minutes for the compressor to start operation. However, the starting time is shortened by short circuit of JPG and JPS.)

8-2. P.C. BOARD MODIFICATION FOR INDIVIDUAL OPERATION

A maximum of 4 indoor units with wireless remote controllers can be used in a room.

In this case, to operate each indoor unit individually by each remote controller, P.C. boards of remote controller must be modified according to the number of the indoor unit.

How to modify the remote controller P.C. board

Remove batteries before modification.

The board has a print as shown below:

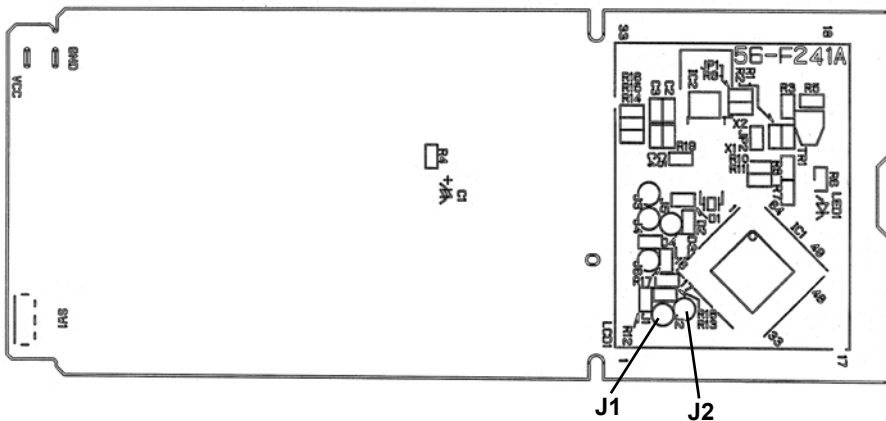

NOTE: For modification, take out the batteries and press the OPERATE/STOP (ON/OFF) button 2 or 3 times at first. After modification, put back the batteries then press the RESET button.

The P.C. board has the print "J1" and "J2". Solder "J1" and "J2" according to the number of indoor unit as shown in Table 1. After modification, press the RESET button.

Table 1

	1 unit operation	2 units operation	3 units operation	4 units operation
No. 1 unit	No modification	Same as at left	Same as at left	Same as at left
No. 2 unit	—	Solder J1	Same as at left	Same as at left
No. 3 unit	—	—	Solder J2	Same as at left
No. 4 unit	—	—	—	Solder both J1 and J2

How to set the remote controller exclusively for particular indoor unit

After you turn the breaker ON, the first remote controller that sends the signal to the indoor unit will be regarded as the remote controller for the indoor unit.

The indoor unit will only accept the signal from the remote controller that has been assigned to the indoor unit once they are set. The setting will be cancelled if the breaker is turned OFF, or the power supply is shut down.

Please conduct the above setting once again after the power has restored.

8-3. AUTO RESTART FUNCTION

When the indoor unit is controlled with the remote controller, the operation mode, the set temperature, and the fan speed are memorized by the indoor electronic control P.C. board. "AUTO RESTART FUNCTION" automatically starts operation in the same mode just before the shutoff of the main power.

Operation

- ① If the main power has been cut, the operation settings remain.
- ② After the power is restored, the unit restarts automatically according to the memory.
(However, it takes at least 3 minutes for the compressor to start running.)

How to disable "AUTO RESTART FUNCTION"

- ① Turn off the main power for the unit.
- ② Solder the jumper wire to JR07 on the indoor electronic control P.C. board (**MS-GF20/25/35VA**).
Cut the jumper wire to JR77 on the indoor electronic control P.C. board (**MS-GF50/60/80VA**). (Refer to 10-7.)

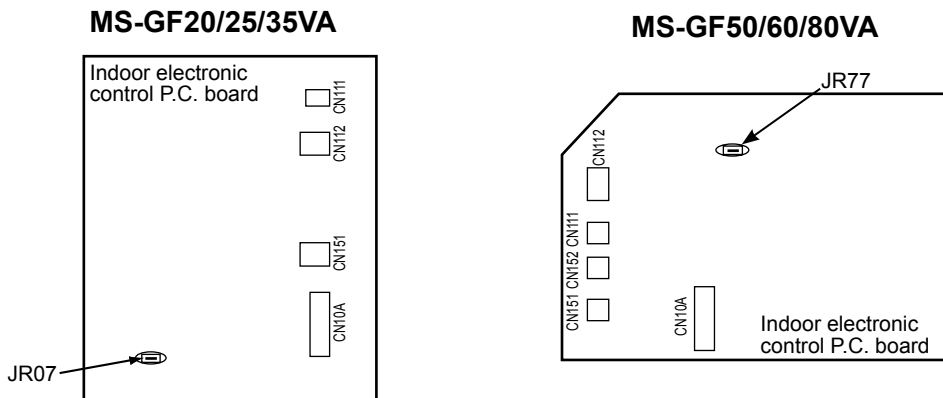

NOTE:

- The operation settings are memorized when 10 seconds have passed after the indoor unit was operated with the remote controller.
- If main power is turned OFF or a power failure occurs while AUTO START/STOP timer is active, the timer setting is cancelled.
- If the unit has been off with the remote controller before power failure, the auto restart function does not work as the power button of the remote controller is OFF.
- To prevent breaker OFF due to the rush of starting current, systematize other home appliance not to turn ON at the same time.
- When some air conditioners are connected to the same supply system, if they are operated before power failure, the starting current of all the compressors may flow simultaneously at restart. Therefore, the special counter-measures are required to prevent the main voltage-drop or the rush of the starting current by adding to the system that allows the units to start one by one.

WIRELESS REMOTE CONTROLLER

MS-GF20VA MS-GF25VA MS-GF35VA

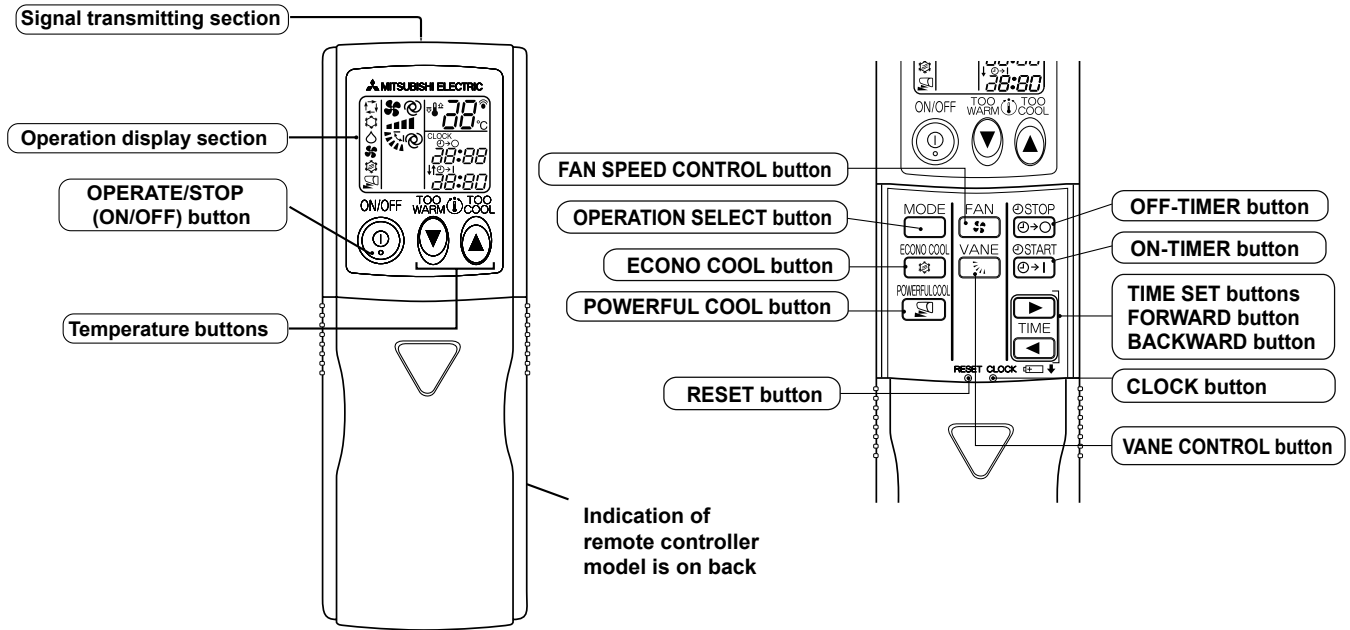

NOTE: Last setting will be stored after the unit is turned OFF with the remote controller. Indoor unit receives the signal of the remote controller with beeps.

MS-GF50VA MS-GF60VA MS-GF80VA

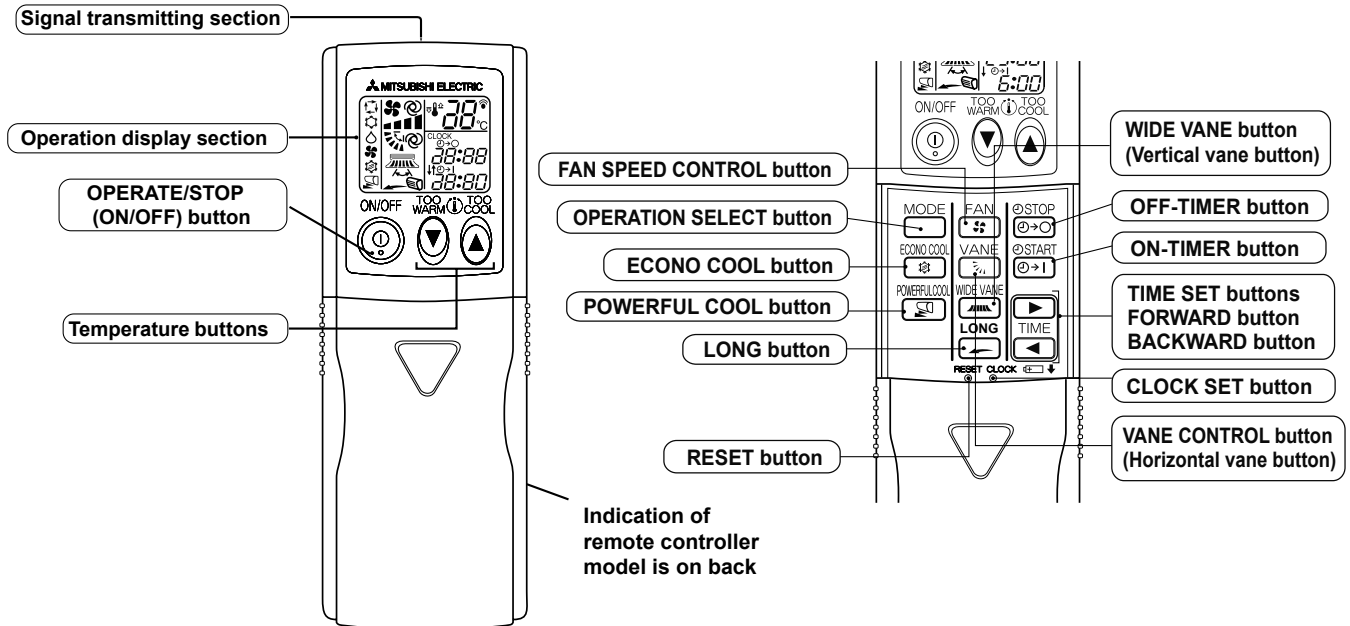

NOTE: Last setting will be stored after the unit is turned OFF with the remote controller. Indoor unit receives the signal of the remote controller with beeps.





INDOOR UNIT DISPLAY SECTION



MS-GF20VA MS-GF25VA MS-GF35VA

Operation Indicator lamp

The operation indicator at the right side of the indoor unit indicates the operation state.

- The following indication applies regardless of shape of the indication.

Indication	Operation state	Room temperature
 	The unit is operating to reach the set temperature	About 2°C or more away from set temperature
 	The room temperature is approaching the set temperature	About 1 to 2°C from set temperature







-  Lighted
-  Blinking
-  Not lighted



MS-GF50VA MS-GF60VA MS-GF80VA

Operation Indicator lamp

The operation indicator at the right side of the indoor unit indicates the operation state.

- The following indication applies regardless of shape of the indication.

Indication	Operation state	Room temperature
 	The unit is operating to reach the set temperature	About 2°C or more away from set temperature
 	The room temperature is approaching the set temperature	About 1 to 2°C from set temperature
 	Standby mode (Only during multi system operation)	—

-  Lighted
-  Blinking
-  Not lighted

9-1. COOL (❄️) OPERATION

- (1) Press OPERATE/STOP (ON/OFF) button.

OPERATION INDICATOR lamp of the indoor unit turns on with a beep tone.

- (2) Select COOL mode with OPERATION SELECT button.

- (3) Press TEMPERATURE buttons (TOO WARM or TOO COOL button) to select the desired temperature. The setting range is 16 - 31°C.

1. Coil frost prevention

When the temperature of indoor heat exchanger becomes too low, the coil frost prevention mode works.

The indoor fan operates at the set speed and the compressor stops. This mode continues until the temperature of indoor heat exchanger rises.

9-2. DRY (△) OPERATION

- (1) Press OPERATE/STOP (ON/OFF) button.
OPERATION INDICATOR lamp of the indoor unit turns on with a beep tone.
- (2) Select DRY mode with OPERATION SELECT button.
- (3) The set temperature is determined from the initial room temperature.

1. Coil frost prevention

Coil frost prevention is as same as COOL mode. (9-1.1.)

9-3. FAN (♣)OPERATION

- (1) Press OPERATE/STOP (ON/OFF) button. OPERATION INDICATOR lamp of the indoor unit turns ON with a beep tone.
- (2) Select FAN mode with OPERATION SELECT button.
- (3) Select the desired fan speed. When AUTO, it becomes Low. Only indoor fan operates. Outdoor unit does not operate.

9-4. "I FEEL CONTROL" (□) OPERATION

- (1) Press OPERATE/STOP (ON/OFF) button on the remote controller. OPERATION INDICATOR lamp of the indoor unit turns ON with a beep tone.
- (2) Select "I FEEL CONTROL" mode with the OPERATION SELECT button.
- (3) The operation mode is determined by the room temperature at start-up of the operation.

Initial room temperature	Mode
25°C or more	COOL mode of "I FEEL CONTROL"
more than 13°C, less than 25°C	DRY mode of "I FEEL CONTROL"

- Once the mode is fixed, the mode does not change by room temperature afterwards.
- Under ON-TIMER (⊖→) operation, mode is determined as follows:
When the system is stopped by the remote controller, and restarted within 2 hours in "I FEEL CONTROL" (□) mode, the system operates in previous mode automatically regardless of the room temperature.

Operation timer chart

Example

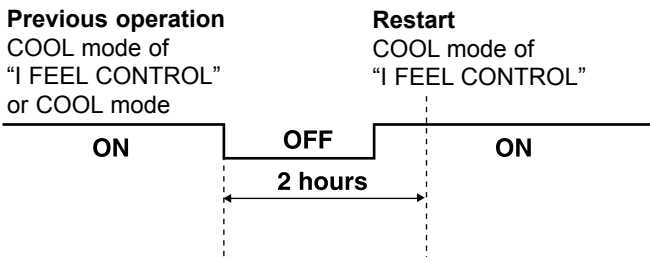

When the system is restarted after 2 hours and more, the operation mode is determined by the room temperature at start-up of the operation.

Operation time chart

Example

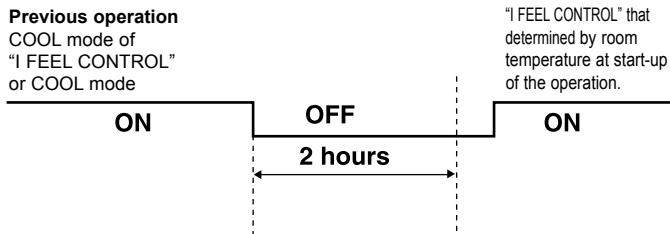

(4) The initial set temperature is decided by the initial room temperature.

Mode	Initial room temperature	Initial set temperature	
COOL mode of "I FEEL CONTROL"	26 °C or more	24 °C	* 1
	25 °C to 26 °C	Initial room temperature minus 2 °C	
DRY mode of "I FEEL CONTROL"	more than 13 °C, less than 25 °C	Initial room temperature minus 2 °C	

*1 When the system is restarted with the remote controller, the system operates with the previous set temperature regardless of the room temperature at restart.

The set temperature is calculated by the previous set temperature.

(5) TEMPERATURE buttons

In "I FEEL CONTROL" mode, set temperature is decided by the microprocessor based on the room temperature.

In addition, set temperature can be controlled by TOO WARM or TOO COOL buttons when you feel too cool or too warm.

Each time TOO WARM or TOO COOL button is pressed, the indoor unit receives the signal and emits a beep tone.

● Fuzzy control

When TOO COOL or TOO WARM button is pressed, the microprocessor changes the set temperature, considering the room temperature, the frequency of pressing TOO COOL or TOO WARM button and the user's preference to heat or cold. So this is called "Fuzzy control", and works only in "I FEEL CONTROL" mode.

In DRY mode of "I FEEL CONTROL", the set temperature does not change.



... To raise the set temperature 1 ~ 2 °C



... To lower the set temperature 1 ~ 2 °C

9-5. AUTO VANE OPERATION

1. Horizontal vane

(1) Vane motor drive

These models are equipped with a stepping motor for the horizontal vane. The rotating direction, speed, and angle of the motor are controlled by pulse signals (approximately 12 V) transmitted from indoor microprocessor.

(2) The horizontal vane angle and mode change as follows by pressing VANE CONTROL button.

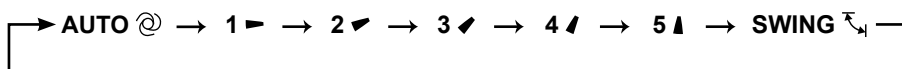

(3) Positioning

To confirm the standard position, the vane moves until it touches the vane stopper. Then the vane is set to the selected angle.

Confirming of standard position is performed in the following cases:

- (a) When the operation starts or finishes (including timer operation).
- (b) When the test run starts.

(4) VANE AUTO (@) mode

In VANE AUTO mode, the microprocessor automatically determines the vane angle to make the optimum room temperature distribution.

Vane angle is fixed to Angle 1.

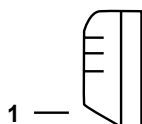

(5) STOP (operation OFF) and ON TIMER standby

In the following cases, the horizontal vane returns to the closed position.

- (a) When OPERATE/STOP (ON/OFF) button is pressed (POWER OFF).
- (b) When the operation is stopped by the emergency operation.
- (c) When ON TIMER is ON standby.

(6) Dew prevention

During COOL or DRY operation with the vane angle at Angle 4 or 5 when the compressor cumulative operation time exceeds 1 hour, the vane angle automatically changes to Angle 1 for dew prevention.

(7) SWING () mode

By selecting SWING mode with VANE CONTROL button, the horizontal vane swings vertically.

(8) ECONO COOL () operation (ECONOMical operation)

When ECONO COOL button is pressed in COOL mode, set temperature is automatically set 2°C higher.

Also the horizontal vane swings in various cycles.

SWING operation makes you feel cooler than set temperature. So, even though the set temperature is higher, the air conditioner can keep comfort. As a result, energy can be saved.

To cancel this operation, select a different mode or press one of the following buttons in ECONO COOL operation:

ECONO COOL, VANE CONTROL or POWERFUL button.

(9) POWERFUL () operation

The air conditioner automatically adjusts the fan speed and the set temperature, and operates the POWERFUL mode.

The POWERFUL mode is cancelled automatically 15 minutes after operation starts. To cancel this operation manually, select a different mode or press one of the following buttons: POWERFUL, OPERATE/STOP (ON/OFF), ECONO COOL, or FAN, SPEED CONTROL button.

(10) LONG MODE () (MS-GF50/60/80VA)

By pressing LONG button indoor fan speed becomes faster than setting fan speed on the remote controller, and the horizontal vane moves to the position for LONG mode. The remote controller displays " ". To cancel this operation, press one of the following buttons: LONG, VANE CONTROL, or ECONO COOL (during cool mode). In the following example, the vertical vane is set to (front.).

2. Vertical vane (MS-GF50/60/80VA)

(1) Vane motor drive

These models are equipped with a stepping motor for the vertical vane. The rotating direction, speed, and angle of the motor are controlled by pulse signals (approximate 12 V) transmitted from microprocessor.

(2) The vertical vane angle and mode change as follows by pressing WIDE VANE CONTROL button.

(3) Positioning

To confirm the standard position, the vane moves until it touches the vane stopper. Then the vane is set to the selected angle.

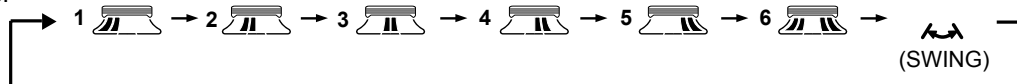

Confirming of standard position is performed in the following cases:

- (a) OPERATE/STOP (ON/OFF) button is pressed (POWER ON).
- (b) SWING is started.

(4) SWING () MODE

By selecting SWING mode with WIDE VANE button, the vertical vane swings horizontally. The remote controller displays " ". Swing mode is cancelled when WIDE VANE button is pressed once again.

(5) WIDE MODE ()

By selecting WIDE mode with WIDE VANE button, indoor fan speed becomes faster than setting fan speed on the remote controller (*). The remote controller displays " ".

* Indoor fan speed becomes faster than setting fan speed on the remote controller even when () or () is selected.

9-6. TIMER OPERATION

1. How to set the time

- (1) Check that the current time is set correctly.

NOTE: Timer operation will not work without setting the current time. Initially "0:00" blinks at the current time display of TIME MONITOR, so set the current time correctly with CLOCK button.

How to set the current time

- (a) Press the CLOCK button.
 (b) Press the TIME SET buttons (▶ and ◀) to set the current time.
 • Each time FORWARD button (▶) is pressed, the set time increases by 1 minute, and each time BACKWARD button (◀) is pressed, the set time decreases by 1 minute.
 • Pressing those buttons longer, the set time increases/decreases by 10 minutes.
 (c) Press the CLOCK button.
 (2) Press OPERATE/STOP (ON/OFF) button to start the air conditioner.
 (3) Set the time of timer.

ON timer setting

- (a) Press ON TIMER button (START) during operation.
 (b) Set the time of the timer using TIME SET buttons (▶ and ◀). ※

OFF timer setting

- (a) Press OFF TIMER button (STOP) during operation.
 (b) Set the time of the timer using TIME SET buttons (▶ and ◀). ※
 ※ Each time FORWARD button (▶) is pressed, the set time increases by 10 minutes: each time BACKWARD button (◀) is pressed, the set time decreases by 10 minutes.

2. To release the timer

To release ON timer, press ON TIMER button (START).

To release OFF timer, press OFF TIMER button (STOP).

TIMER is cancelled and the display of set time disappears.

PROGRAM TIMER

- OFF timer and ON timer can be used in combination. The timer of the set time that is reached first will operate first.
- "↓" and "↑" display shows the order of OFF timer and ON timer operation.

(Example 1) The current time is 8:00 PM.

The unit turns off at 11:00 PM, and on at 6:00 AM.

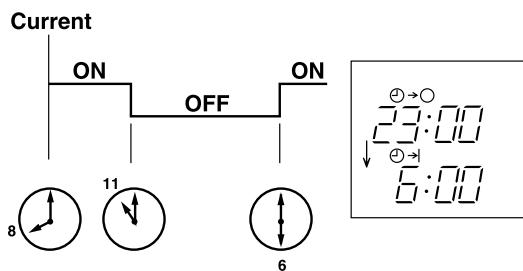

(Example 2) The current time is 11:00 AM.

The unit turns on at 5:00 PM, and off at 9:00 PM.

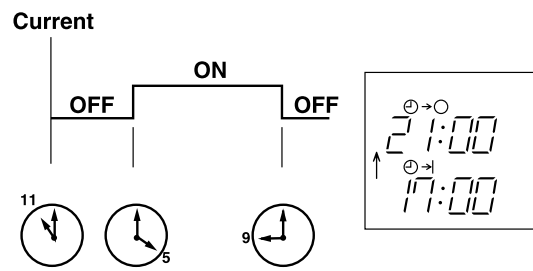

NOTE: If the main power is turned OFF or a power failure occurs while ON/OFF timer is active, the timer setting is cancelled. As these models are equipped with an auto restart function, the air conditioner starts operating with timer cancelled when power is restored.

9-7. EMERGENCY/TEST OPERATION

In case of test run operation or emergency operation, use EMERGENCY OPERATION switch on the right side of the indoor unit. Emergency operation is available when the remote controller is missing, has failed or the batteries of the remote controller run down. The unit will start and OPERATION INDICATOR lamp will light. The first 30 minutes of operation is the test run operation. This operation is for servicing. The indoor fan runs at High speed and the temperature control does not work. After 30 minutes of test run operation, the system shifts to EMERGENCY COOL MODE with a set temperature of 24°C. The fan speed shifts to Med. The coil frost prevention works even in the test run or the emergency operation. In the test run or emergency operation, the horizontal vane operates in VANE AUTO (@) mode. Emergency operation continues until EMERGENCY OPERATION switch is pressed again or the unit receives any signal from the remote controller. In case of latter, normal operation will start.

Operation mode	COOL
Set temperature	24°C
Fan speed	Med.
Horizontal vane	Auto

The operation mode is indicated by the Operation Indicator lamp as following

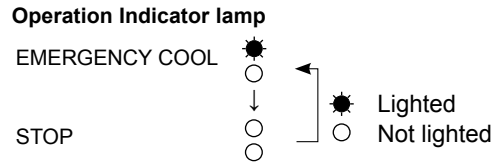

NOTE: Do not press EMERGENCY OPERATION switch during normal operation.

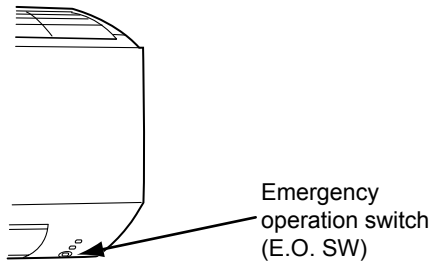

9-8. 3-MINUTE TIME DELAY OPERATION

When the system turns OFF, compressor will not restart for 3 minutes as 3-minute time delay function operates to protect compressor from overload.

MS-GF20VA MS-GF25VA MS-GF35VA MS-GF50VA MS-GF60VA MS-GF80VA

10-1. CAUTIONS ON TROUBLESHOOTING

1. Before troubleshooting, check the following

- 1) Check the power supply voltage.
- 2) Check the indoor/outdoor connecting wire for miswiring.

2. Take care of the following during servicing

- 1) Before servicing the air conditioner, be sure to turn OFF the main unit first with the remote controller, and then after confirming the horizontal vane is closed, turn OFF the breaker and/or disconnect the power plug.
- 2) Be sure to turn OFF the power supply before removing the front panel, the cabinet, the top panel, and the P.C. board.
- 3) When removing the P.C. board, hold the edge of the board with care NOT to apply stress on the components.
- 4) When connecting or disconnecting the connectors, hold the housing of the connector. DO NOT pull the lead wires.

<Incorrect>

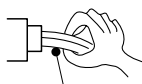

Lead wiring

<Correct>

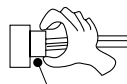

Housing point

3. Troubleshooting procedure

- 1) Check if the OPERATION INDICATOR lamp on the indoor unit is flashing ON and OFF to indicate an abnormality. To make sure, check how many times the OPERATION INDICATOR lamp is flashing ON and OFF before starting service work.
- 2) Before servicing, check that the connector and terminal are connected properly.
- 3) When the electronic control P.C. board seems to be defective, check the copper foil pattern for disconnection and the components for bursting and discoloration.
- 4) When troubleshooting, Refer to 10-2, 10-3 and 10-4.

4. How to replace batteries

Weak batteries may cause the remote controller malfunction.

In this case, replace the batteries to operate the remote controller normally.

- ① Remove the front lid and insert batteries.

Then reattach the front lid.

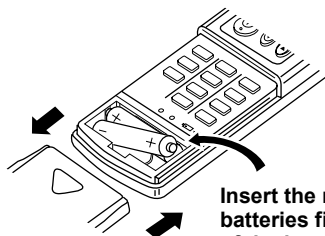

Insert the negative pole of the batteries first. Check if the polarity of the batteries is correct.

- ② Press RESET button with a thin instrument, and

then use the remote controller.

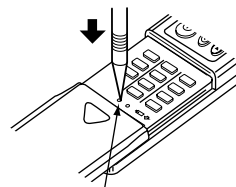

RESET button

NOTE: 1. If RESET button is not pressed, the remote controller may not operate correctly.

2. This remote controller has a circuit to automatically reset the microcomputer when batteries are replaced.

This function is equipped to prevent the microcomputer from malfunctioning due to the voltage drop caused by the battery replacement.

3. Do not use the leaking batteries.

10-2. FAILURE MODE RECALL FUNCTION

Outline of the function

This air conditioner can memorize the abnormal condition which has occurred once.

Even though LED indication listed on the troubleshooting check table (10-4.) disappears, the memorized failure details can be recalled.

1. Flow chart of failure mode recall function for the indoor unit

MS-GF20/25/35VA

MS-GF50/60/80VA

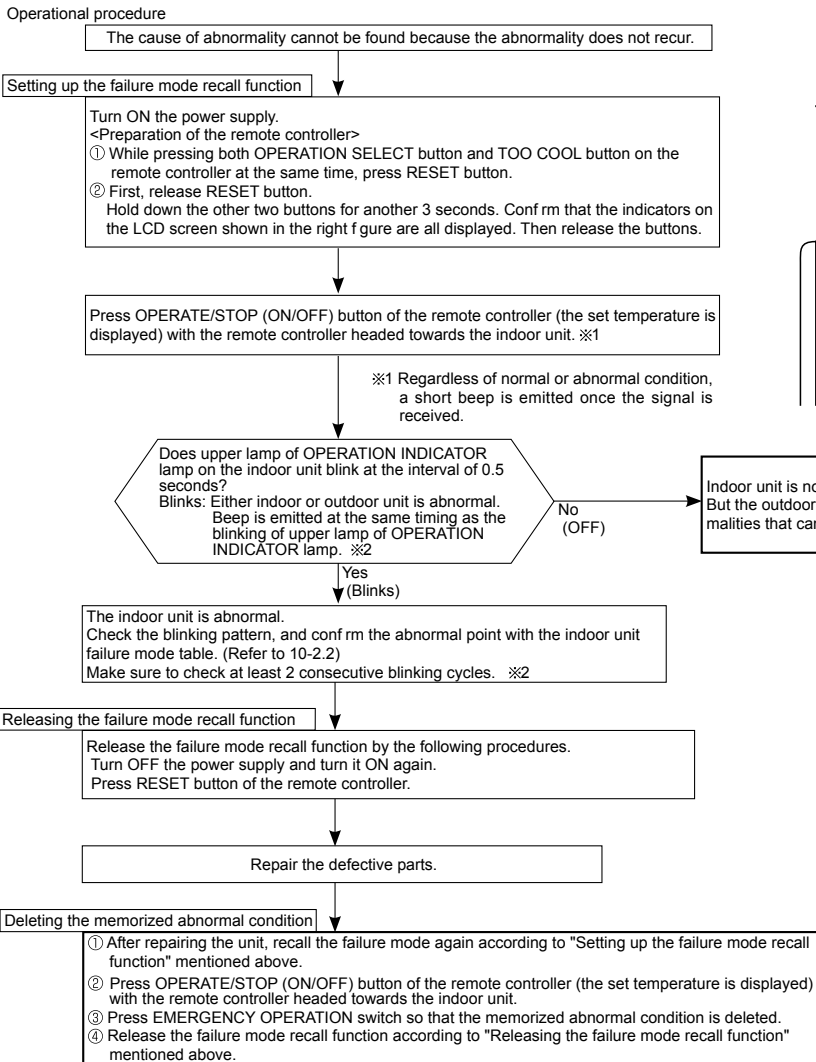
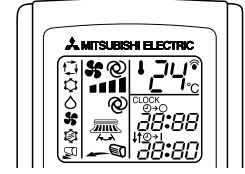
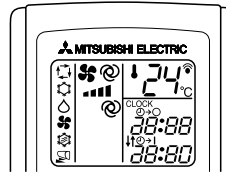
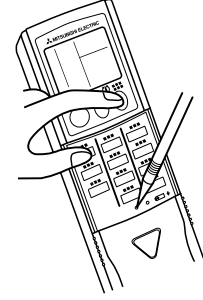
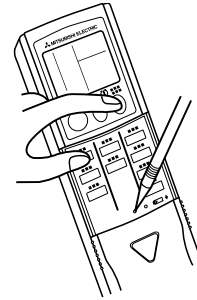

NOTE: 1. Make sure to release the failure mode recall function once it is set up, otherwise the unit cannot operate properly.
2. If the abnormal condition is not deleted from the memory, the last abnormal condition is kept memorized.

※2. Blinking pattern when the indoor unit is abnormal:

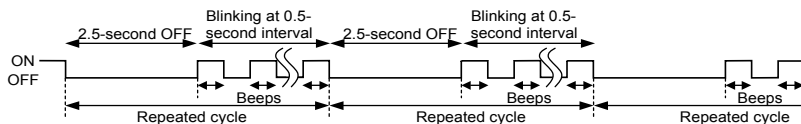

2. Indoor unit failure mode table

Upper lamp of OPERATION INDICATOR lamp	Abnormal point (Failure mode)	Condition	Remedy
Not lighted	Normal	—	—
1-time flash every 0.5-second	Room temperature thermistor	The room temperature thermistor short or open circuit is detected every 8 seconds during operation.	Refer to the characteristics of the room temperature thermistor (10-7.).
2-time flash 2.5-second OFF	Indoor coil thermistor	The indoor coil thermistor short or open circuit is detected every 8 seconds during operation.	Refer to the characteristics of the indoor coil thermistor (10-7.).
11-time flash 2.5-second OFF	Indoor fan motor	The rotational frequency feedback signal is not emitted for 12 seconds after the indoor fan motor is operated.	Refer to 10-6.④ "Check of indoor fan motor".
12-time flash 2.5-second OFF	Indoor control system	It cannot properly read data in the nonvolatile memory of the indoor electronic control P.C. board.	Replace the indoor electronic control P.C. board.
14-time flash ※1 2.5-second OFF	Refrigerant circuit	Refer to 10-4. No.4 "Condition".	Refer to 10-4. No.4 "Remedy".

NOTE: Blinking patterns of this mode differ from the ones of TROUBLESHOOTING CHECK TABLE (10-4.).

※1. A blinking pattern when "14-time flash" is displayed :

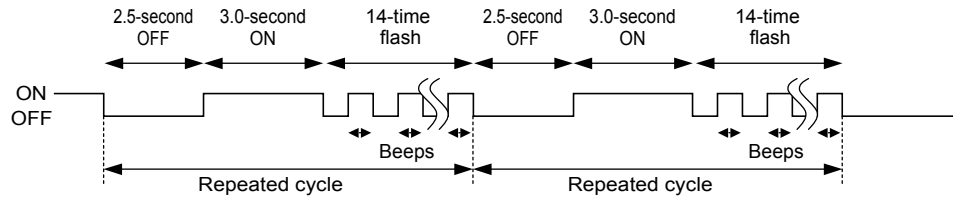

10-3. INSTRUCTION OF TROUBLESHOOTING

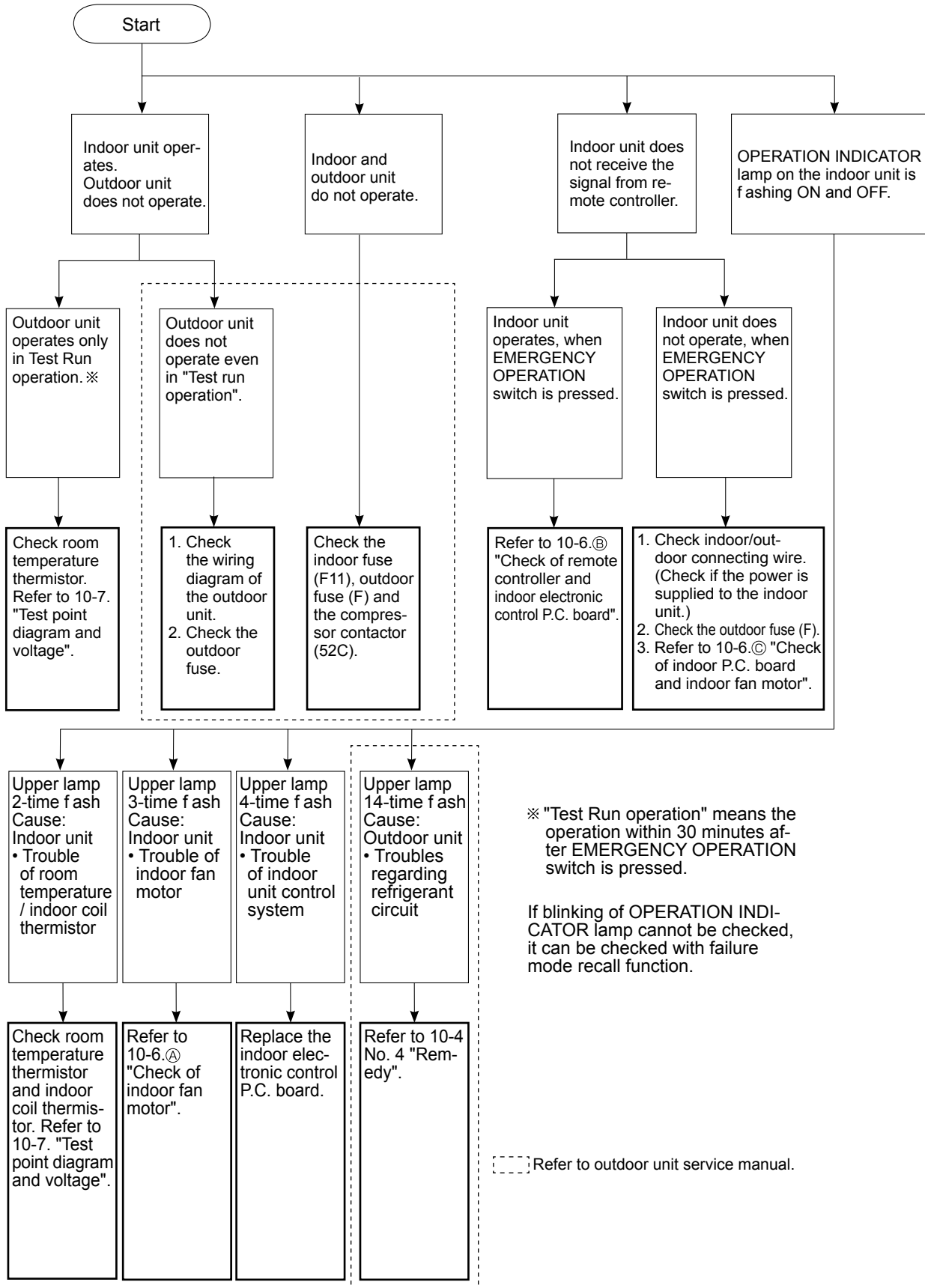

10-4. TROUBLESHOOTING CHECK TABLE

Before taking measures, make sure that the symptom reappears for accurate troubleshooting.

When the indoor unit has started operation and detected an abnormality of the following condition (the first detection after the power ON), the indoor fan motor turns OFF and OPERATION INDICATOR lamp flashes.

Operation Indicator lamp

The operation indicator lamp is at the right side of the indoor unit.

- The following indication applies regardless of shape of the indication.

OPERATION INDICATOR

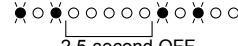
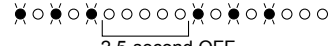
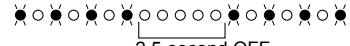
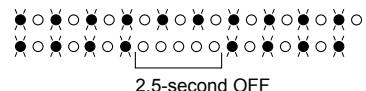

No.	Abnormal point	Operation indicator lamp	Symptom	Condition	Remedy
1	Indoor coil thermistor	Upper lamp f ashes. 2-time f ash 	Indoor unit and outdoor unit do not operate.	The indoor coil or the room temperature thermistor is short or open circuit.	• Refer to the characteristics of indoor coil thermistor, and the room temperature thermistor (10-7.).
	Room temperature thermistor				
2	Indoor fan motor	Upper lamp f ashes. 3-time f ash 		The rotational frequency feedback signal is not emitted during the indoor fan operation.	• Refer to 10-6. ④ "Check of indoor fan motor".
3	Indoor control system	Upper lamp f ashes. 4-time f ash 		It cannot properly read data in the nonvolatile memory of the indoor electronic control P.C. board.	• Replace the indoor electronic control P.C. board.
4 ※1	Refrigerant circuit	Upper lamp f ashes. 14-time f ash 	The unit has been pumped down for a long time.	• Check the stop valve.	
			The refrigerant amount is low.	• Check the connections and the refrigerant amount for any leakage.	
			The unit is short cycling.	• Check for short cycle. If any problem is found, provide some space for air path around the outdoor unit.	
			The outdoor fan motor locks up.	• Check that the connecting cable of the outdoor fan motor is properly connected. • Check the resistance value of the outdoor fan motor. If any problem is found, replace the outdoor fan motor.	

※1. When the trouble indicated with 14-time f ash occurs, turn off the main power supply.

Otherwise, the operation indicator lamp may f ash again even if the power is turned off and on using a remote controller.

10-5. TROUBLE CRITERION OF MAIN PARTS

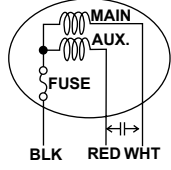
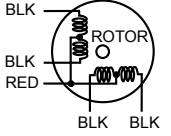
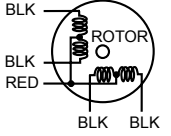
Part name	Check method and criterion	Figure								
Room temperature thermistor (RT11) Indoor coil thermistor (RT12)	Measure the resistance with a tester. Refer to 10-7. "Test point diagram and voltage", "1. Indoor electronic control P.C. board", for the chart of thermistor.									
MS-GF20/25/35VA Indoor fan motor (MF) INNER FUSE 145 °C CUT OFF	Measure the resistance with a tester. (Part temperature 10 ~ 30 °C) <table border="1"> <thead> <tr> <th>Color of the lead wire</th> <th>Normal</th> </tr> </thead> <tbody> <tr> <td>WHT-BLK</td> <td>334 Ω ~ 362 Ω</td> </tr> <tr> <td>BLK-RED</td> <td>370 Ω ~ 402 Ω</td> </tr> </tbody> </table>	Color of the lead wire	Normal	WHT-BLK	334 Ω ~ 362 Ω	BLK-RED	370 Ω ~ 402 Ω			
Color of the lead wire	Normal									
WHT-BLK	334 Ω ~ 362 Ω									
BLK-RED	370 Ω ~ 402 Ω									
MS-GF50/60/80VA Indoor fan motor (MF)	Check 10-6.Ⓐ "Check of indoor fan motor".									
MS-GF20/25/35VA Horizontal vane motor (MV)	Measure the resistance between the terminals with a tester. (Temperature: 10 - 30°C) <table border="1"> <thead> <tr> <th>Color of the lead wire</th> <th>Normal</th> </tr> </thead> <tbody> <tr> <td>RED-BLK</td> <td>223 Ω ~ 268 Ω</td> </tr> </tbody> </table>	Color of the lead wire	Normal	RED-BLK	223 Ω ~ 268 Ω					
Color of the lead wire	Normal									
RED-BLK	223 Ω ~ 268 Ω									
MS-GF50/60/80VA Horizontal vane motor (MV1) Vertical vane motor (MV2)	Measure the resistance between the terminals with a tester. (Temperature: 10 - 30°C) <table border="1"> <thead> <tr> <th></th> <th>Color of the lead wire</th> <th>Normal</th> </tr> </thead> <tbody> <tr> <td>Horizontal vane motor (MV1)</td> <td rowspan="2">RED-BLK</td> <td>313 ~ 375 Ω</td> </tr> <tr> <td>Vertical vane motor (MV2)</td> <td>268 ~ 322 Ω</td> </tr> </tbody> </table>		Color of the lead wire	Normal	Horizontal vane motor (MV1)	RED-BLK	313 ~ 375 Ω	Vertical vane motor (MV2)	268 ~ 322 Ω	
	Color of the lead wire	Normal								
Horizontal vane motor (MV1)	RED-BLK	313 ~ 375 Ω								
Vertical vane motor (MV2)		268 ~ 322 Ω								

10-6. TROUBLESHOOTING FLOW

Ⓐ Check of indoor fan motor

MS-GF20/25/35VA

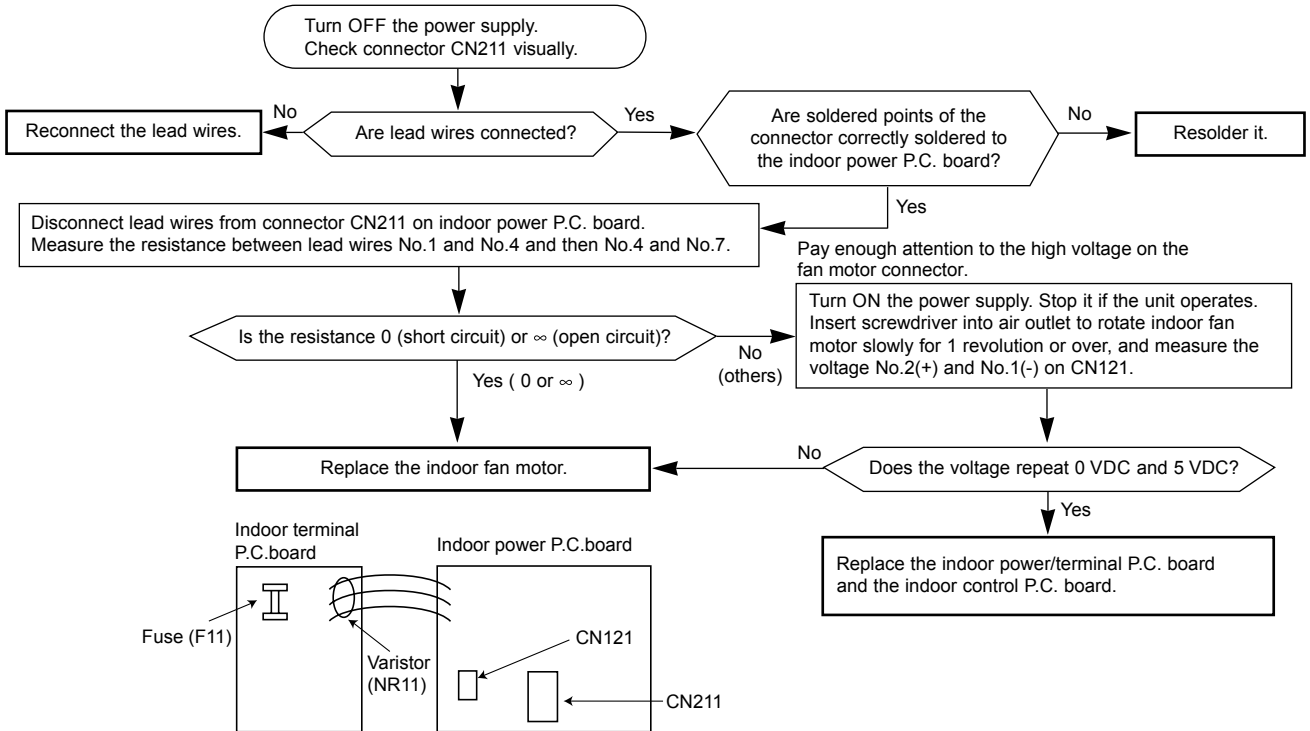

MS-GF50/60/80VA

The indoor fan motor error has occurred, and the indoor fan does not operate.

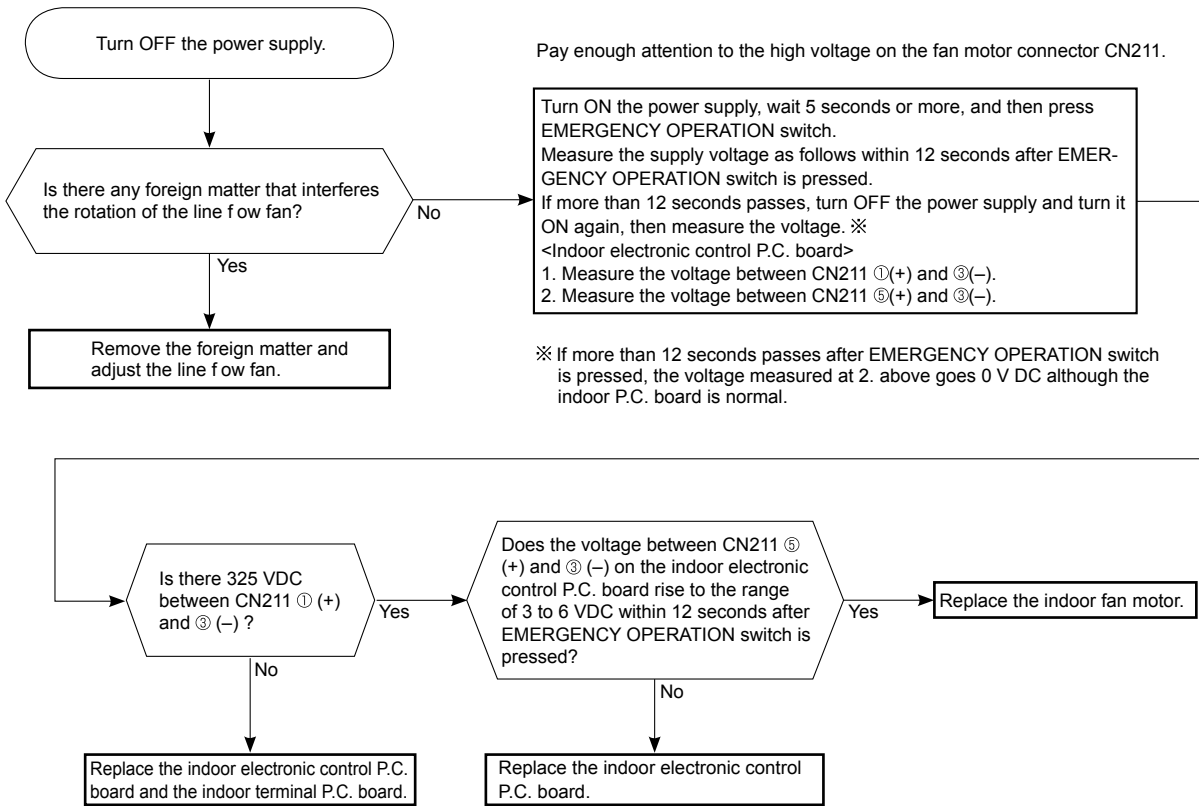

The indoor fan motor error has occurred, and the indoor fan repeats "12-second ON and 30-second OFF" 3 times, and then stops.

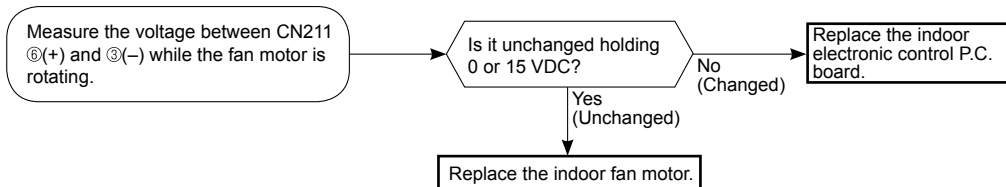

B Check of remote controller and indoor electronic control P.C. board

※Check if the remote controller is exclusive for this air conditioner.

MS-GF20/25/35VA

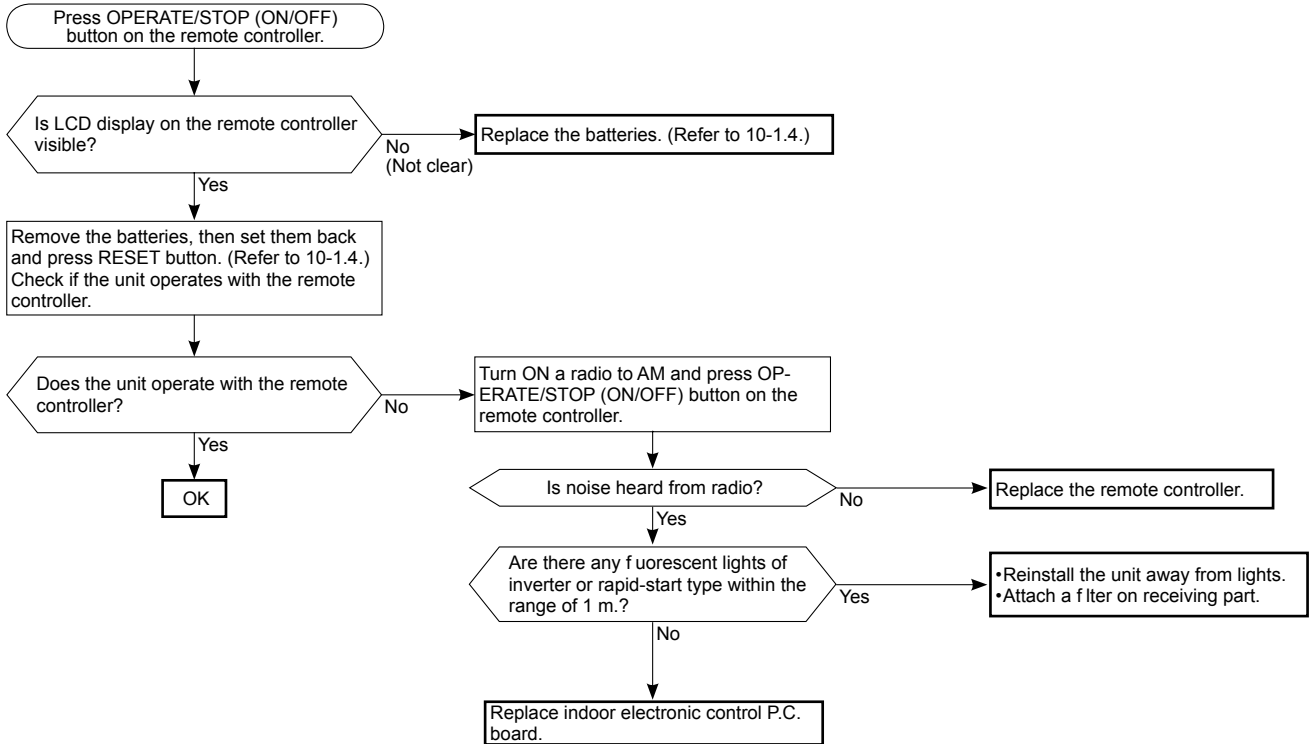

MS-GF50/60/80VA

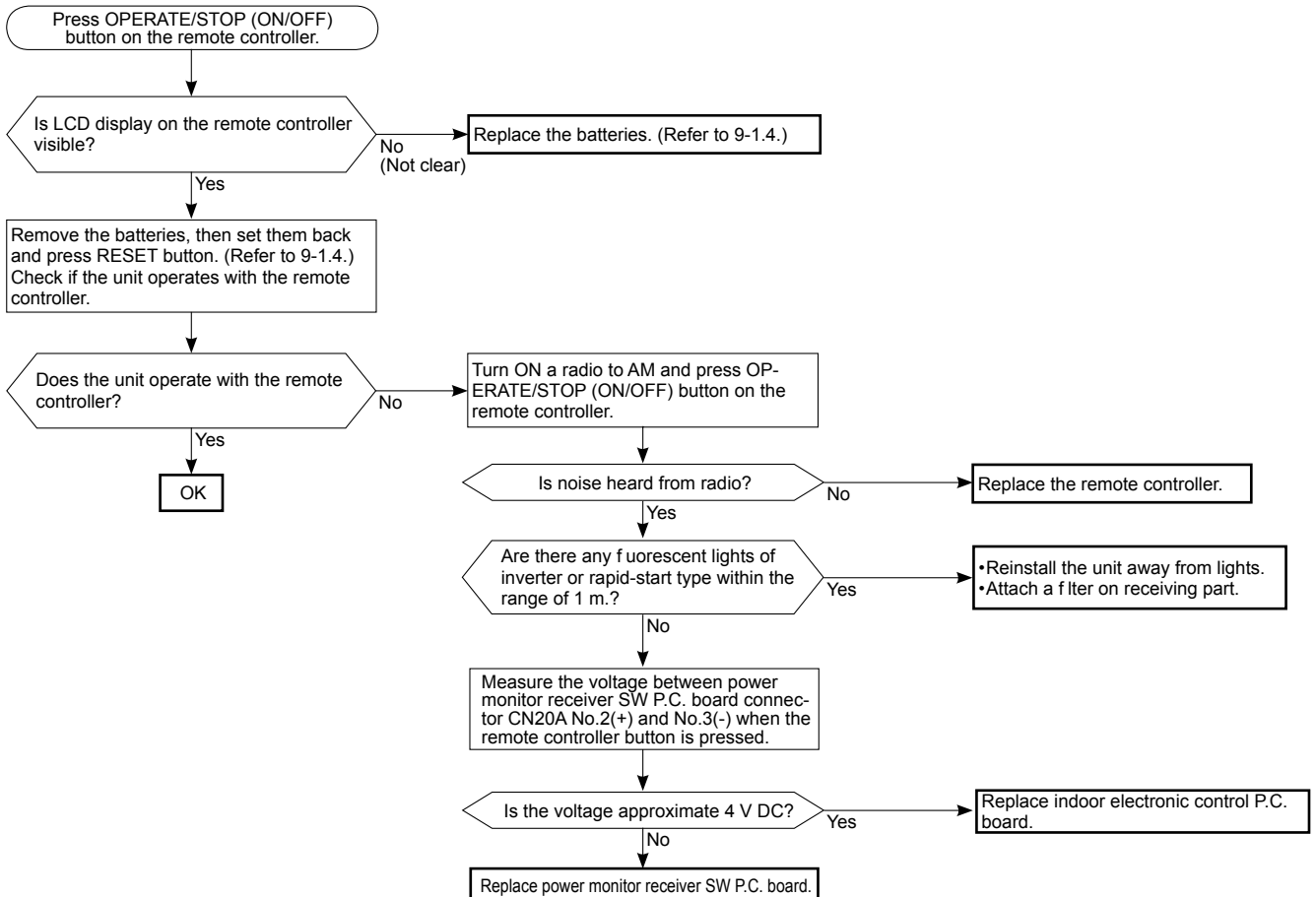

© Check of indoor electronic control P.C. board and indoor fan motor

MS-GF20/25/35VA

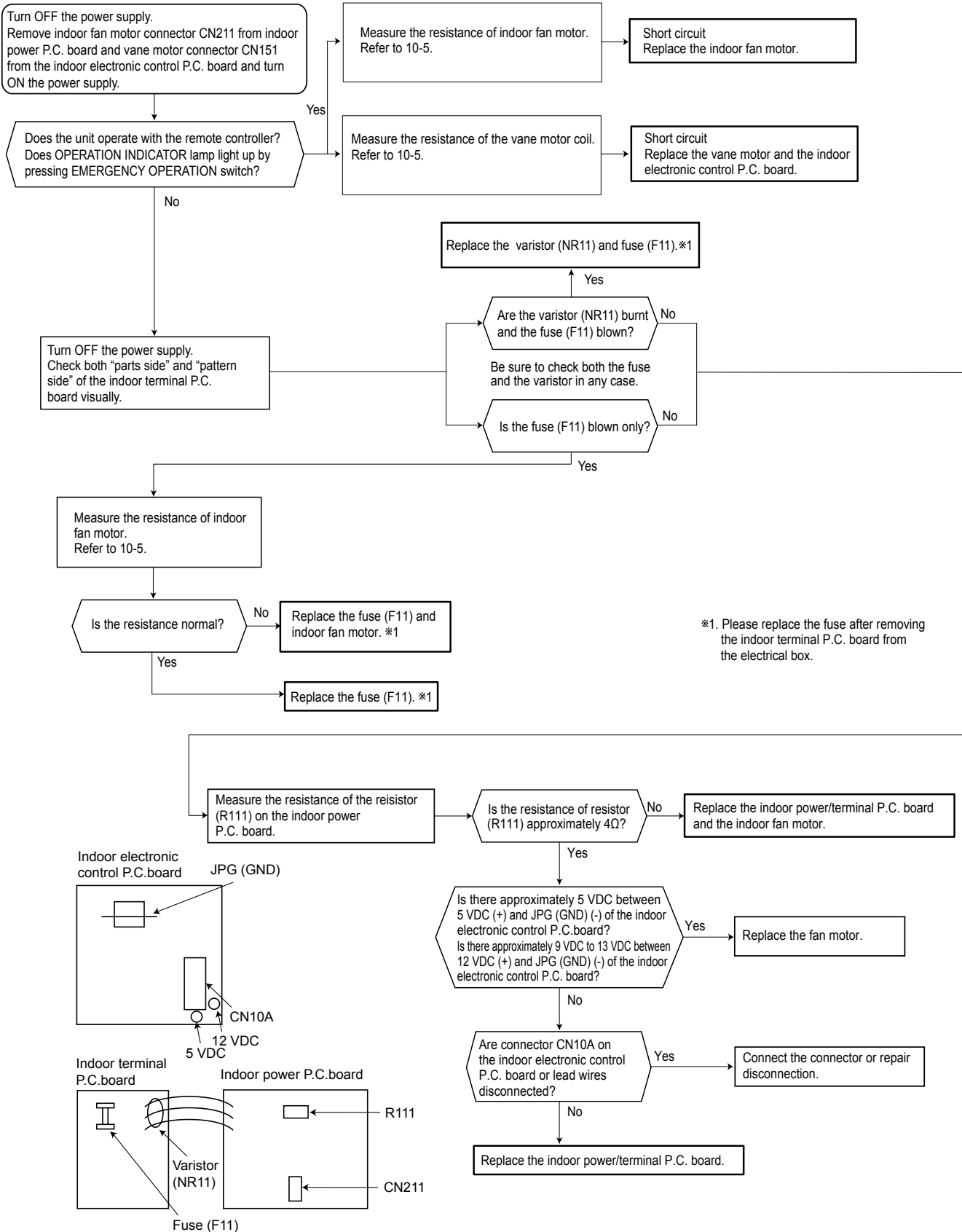

MS-GF50/60/80VA

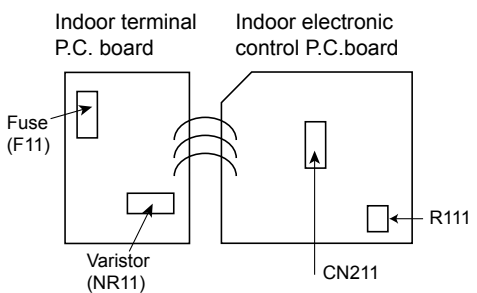
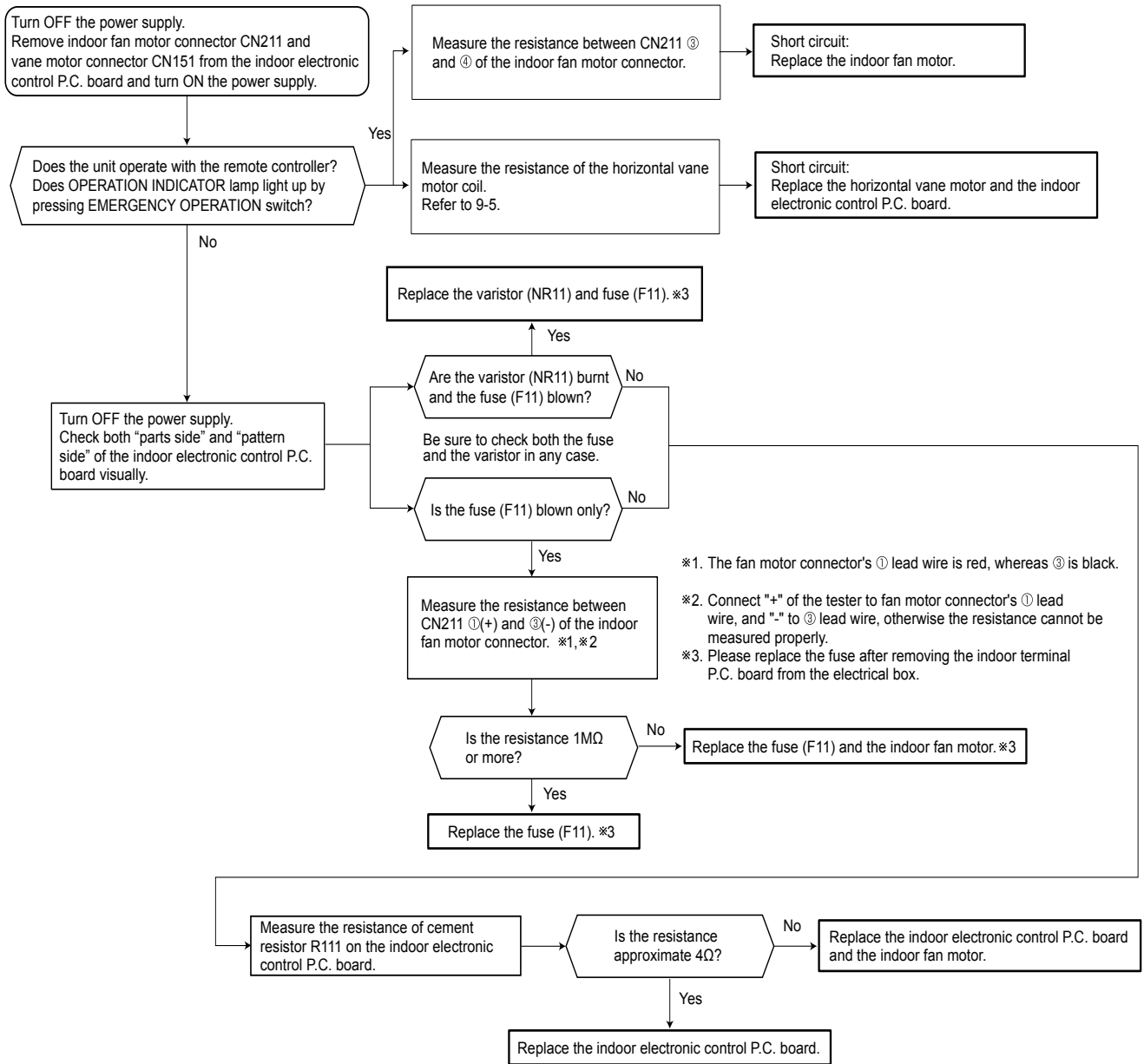

D Electromagnetic noise enters into TV sets or radios

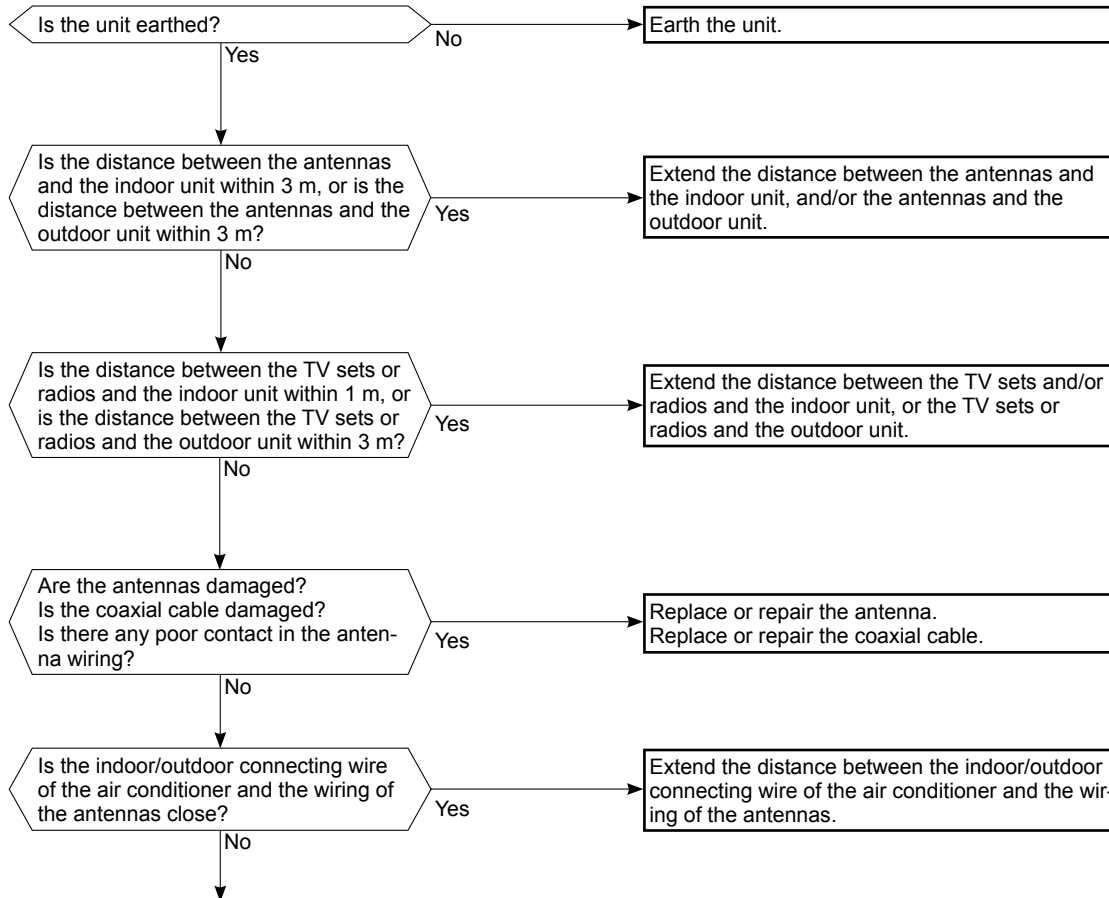

Even if all of the above conditions are fulfilled, the electromagnetic noise may enter, depending on the electric field strength or the installation condition (combination of specific conditions such as antennas or wiring). Check the following before asking for service.

1. Devices affected by the electromagnetic noise
TV sets, radios (FM/AM broadcast, shortwave)
2. Channel, frequency, broadcast station affected by the electromagnetic noise
3. Channel, frequency, broadcast station unaffected by the electromagnetic noise
4. Layout of:
indoor/outdoor unit of the air conditioner, indoor/outdoor wiring, earth wire, antennas, wiring from antennas, receiver
5. Electric field intensity of the broadcast station affected by the electromagnetic noise
6. Presence or absence of amplifier such as booster
7. Operation condition of air conditioner when the electromagnetic noise enters in
 - 1) Turn OFF the power supply once, and then turn ON the power supply. In this situation, check for the electromagnetic noise.
 - 2) Within 3 minutes after turning ON the power supply, press OPERATE/STOP (ON/OFF) button on the remote controller for power ON, and check for the electromagnetic noise.
 - 3) After a short time (3 minutes later after turning ON), the outdoor unit starts running. During operation, check for the electromagnetic noise.
 - 4) Press OPERATE/STOP (ON/OFF) button on the remote controller for power OFF, when the outdoor unit stops but the indoor/outdoor communication still runs on. In this situation, check for the electromagnetic noise.

10-7. TEST POINT DIAGRAM AND VOLTAGE
1. Indoor electronic control P.C. board
MS-GF20VA MS-GF25VA MS-GF35VA

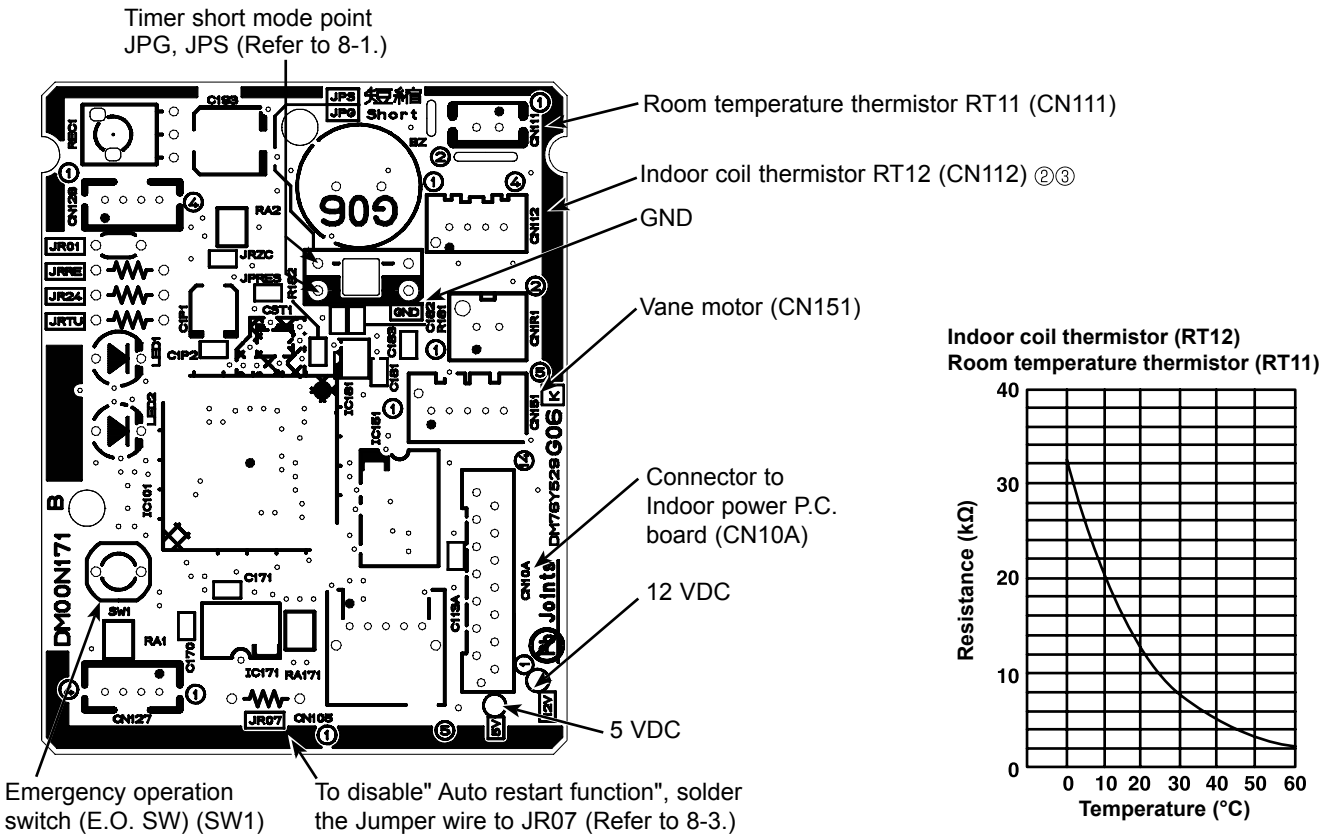

2. Indoor terminal P.C. board Indoor power P.C. board
MS-GF20VA MS-GF25VA MS-GF35VA

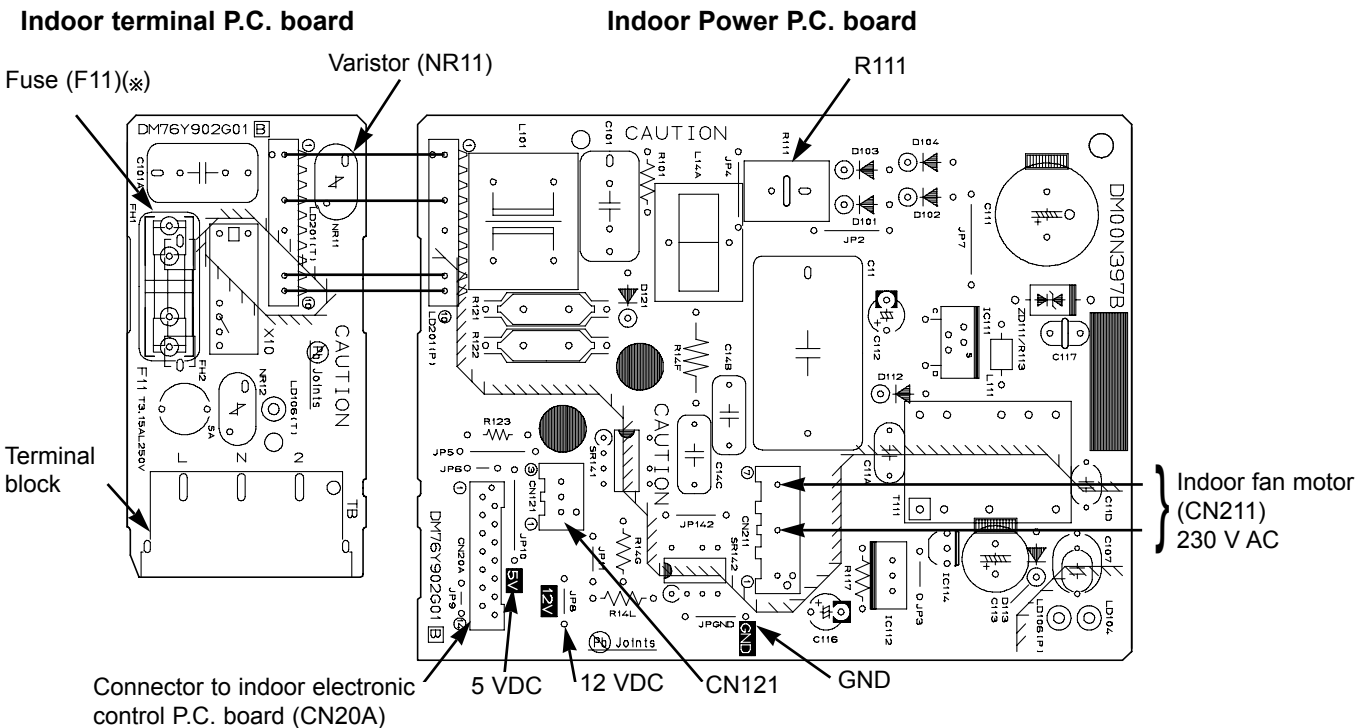

※ Please replace the fuse after removing the indoor terminal P.C. board from the electrical box.

**3. Indoor electronic control P.C. board, Indoor terminal P.C. board, Power monitor receiver SW P.C. board
MS-GF50VA MS-GF60VA MS-GF80VA**

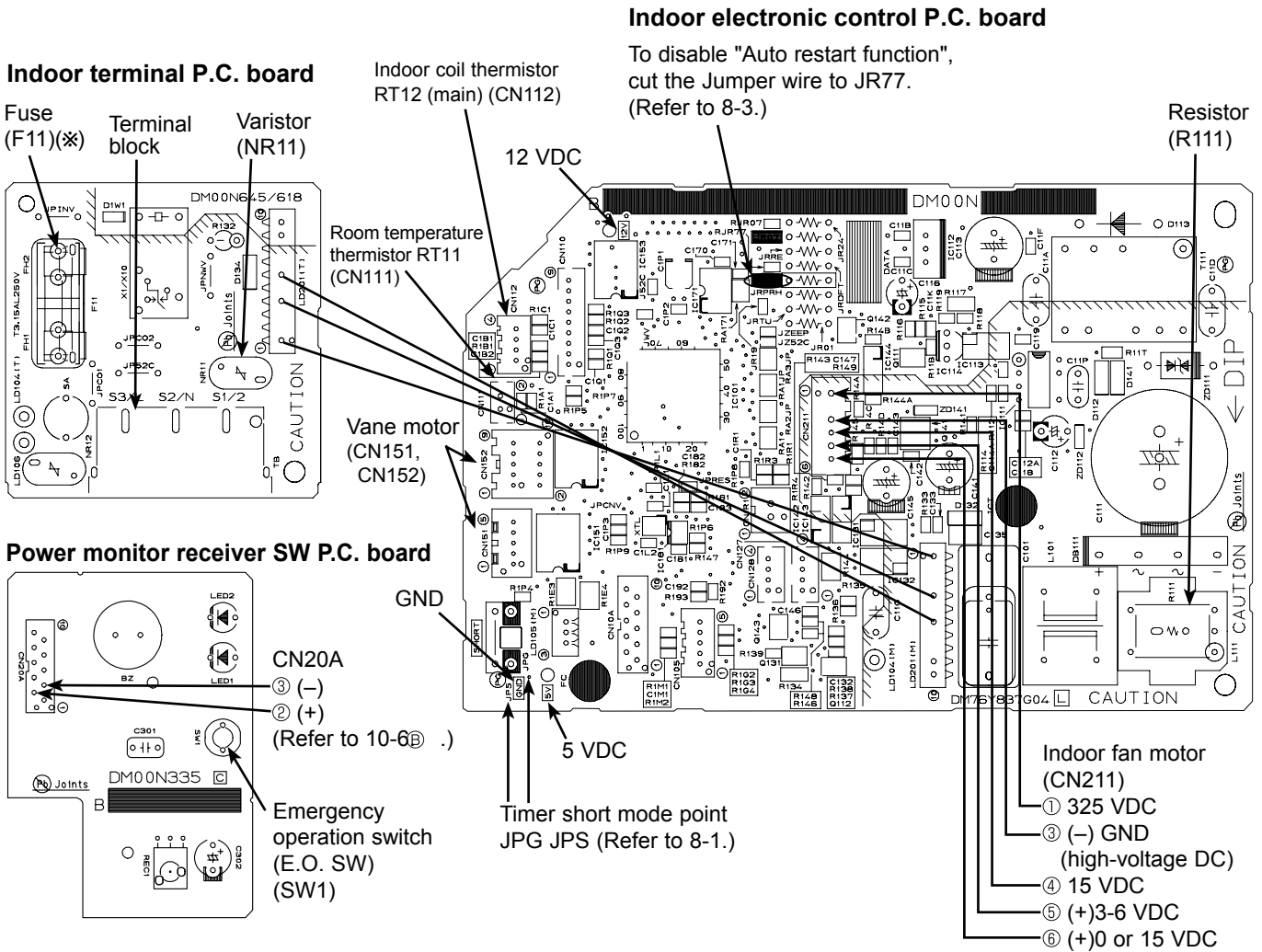

* Replace the fuse after removing the indoor terminal P.C. board from the electrical box.

**Room temperature thermistor (RT11)
Indoor coil thermistor (RT12)**

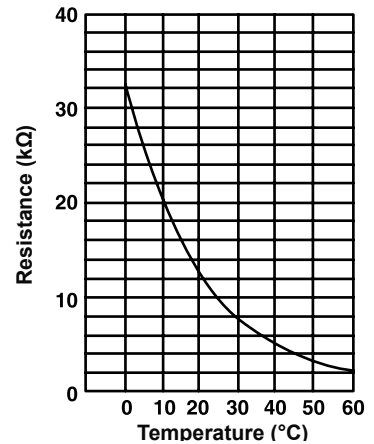

<"Terminal with locking mechanism" Detaching points>

The terminal which has the locking mechanism can be detached as shown below.

There are two types (refer to (1) and (2)) of the terminal with locking mechanism.

The terminal without locking mechanism can be detached by pulling it out.

Check the shape of the terminal before detaching.

(1) Slide the sleeve and check if there is a locking lever or not.

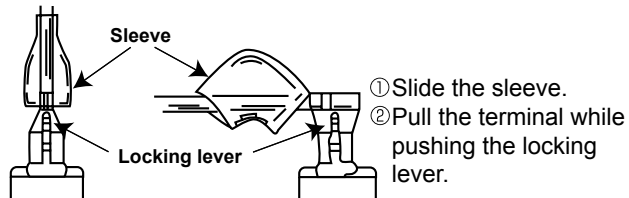

(2) The terminal with this connector has the locking mechanism.

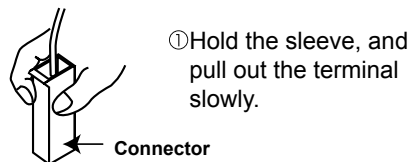

11-1. MS-GF20VA MS-GF25VA MS-GF35VA

NOTE: Turn OFF power supply before disassembly.

OPERATING PROCEDURE	PHOTOS
<p>1. Removing the panel</p> <ol style="list-style-type: none"> (1) Remove the horizontal vanes. (2) Remove the screw caps of the panel. Remove the screws of the panel. (3) Unhook the lower part (A) of the panel. (4) Hold the lower part of both ends of the panel and pull it slightly toward you, and then remove the panel by pushing it upward. 	<p>Photo 1</p>

OPERATING PROCEDURE

2. Removing the indoor electronic control P.C. board and the room temperature thermistor

- (1) Remove the panel (Refer to 1.) and the corner box.
- (2) Remove the screw of the V.A. clamp and the V.A. clamp.
- (3) Remove the screw of the electrical cover and the electrical cover.
- (4) Remove the indoor/outdoor connecting wire.
- (5) Open the indoor electronic control P.C. board holder (to right side).
- (6) Disconnect the following connectors:
<Indoor electronic control P.C. board>
CN10A (To the indoor power P.C. board)
CN112 (Indoor coil thermistor)
CN151 (Vane motor)
- (7) Unhook the catches of the indoor electronic control P.C. board holder from the nozzle and the electrical box (right side).
- (8) Remove the room temperature thermistor from the hook of the indoor electronic control P.C. board holder.
- (9) Open the back side of the indoor electronic control P.C. board holder, and remove the indoor electronic control P.C. board.
- (10) Remove the room temperature thermistor from the indoor electronic control P.C. board.

3. Remove the indoor power P.C. board, the indoor terminal P.C. board, and the electrical box

- (1) Remove the panel (Refer to 1.) and the corner box.
- (2) Remove the indoor/outdoor connecting wire (Refer to 2 (2)-(4)).
- (3) Remove the earth wire connected to the indoor heat exchanger from the electrical box.
- (4) Unhook first the lower, then the upper catches of the electrical box, and pull out the electrical box.
- (5) Disconnect all the connectors on the indoor power P.C. board and unhook all lead wires.
- (6) Remove the screw of terminal block on the indoor terminal P.C. board.
- (7) Remove the indoor power P.C. board and the indoor terminal P.C. board.

PHOTOS

Photo 2

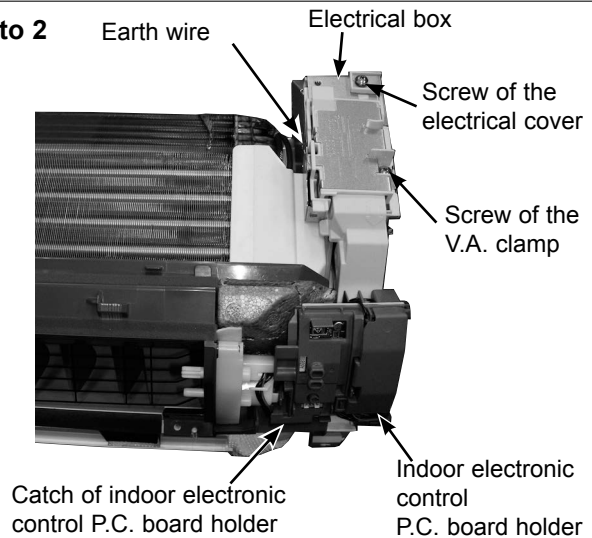
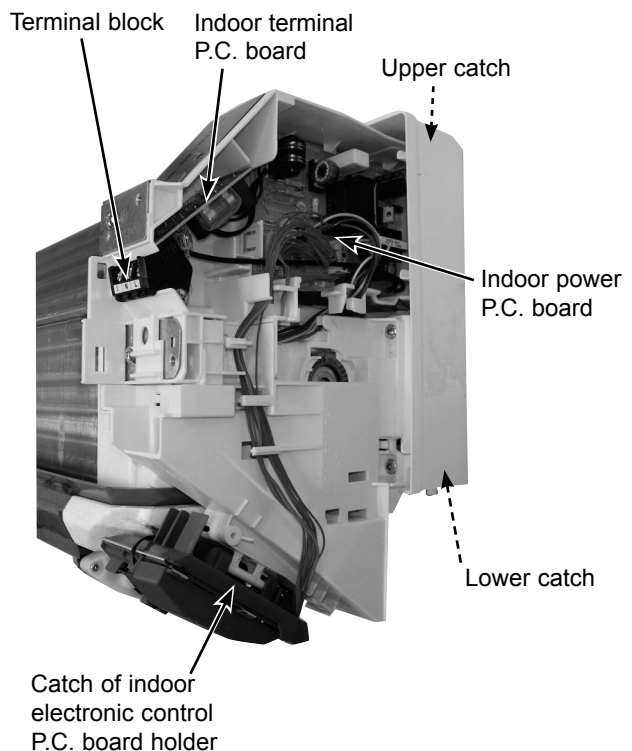

Photo 3



OPERATING PROCEDURE

4. Removing the nozzle assembly

- (1) Remove the panel (Refer to 1.) and the corner box.
- (2) Remove the indoor/outdoor connecting wire (Refer to 2 (2)-(4)).
- (3) Remove the indoor electronic control P.C. board holder.
- (4) Pull out the drain hose from the nozzle assembly and remove the nozzle assembly.

5. Removing the horizontal vane motor

- (1) Remove the nozzle assembly. (Refer to 4.)
- (2) Remove the screws of the horizontal vane motor unit.
- (3) Disconnect the connector from the horizontal vane motor.
- (4) Remove the screws of the horizontal vane motor.
- (5) Remove the horizontal vane motor from the horizontal vane motor unit.

PHOTOS

Photo 4

Screws of horizontal vane motor unit

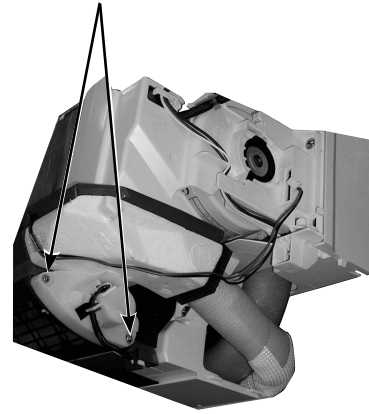

OPERATING PROCEDURE

6. Removing the indoor fan motor, the indoor coil thermistor, and the line flow fan

- (1) Remove the panel (Refer to 1.) and the corner box.
- (2) Remove the indoor electronic control P.C. board holder, the electrical box and the nozzle assembly.
- (3) Remove the screws fixing the motor bed.
- (4) Loosen the screw fixing the line flow fan.
- (5) Remove the motor bed together with fan motor and motor band.
- (6) Release the hooks of the motor band. Remove the motor band. Pull out the indoor fan motor.
- (8) Remove the indoor coil thermistor from the heat exchanger.
- (*) Install the indoor coil thermistor in its former position when assembling it. (Refer to Photo 8)
- (9) Remove the screws fixing the left side of the heat exchanger.
- (10) Lift the heat exchanger, and pull out the line flow fan to the lower-left.

Photo 8

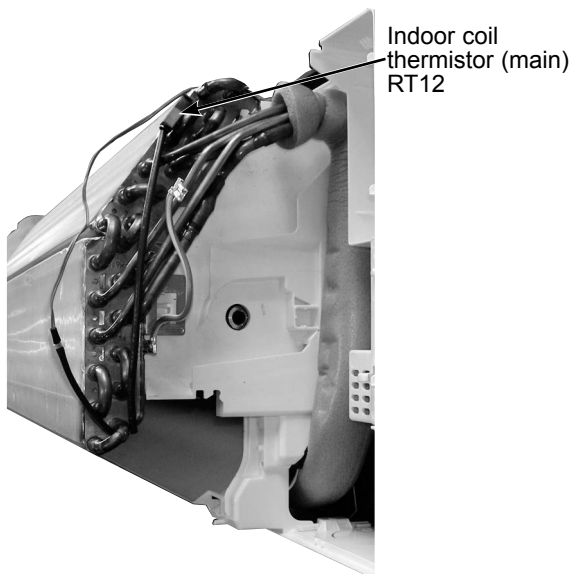

PHOTOS

Photo 5

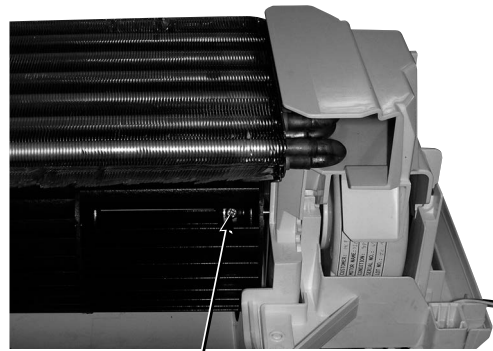

Screw of the line flow fan

Photo 6

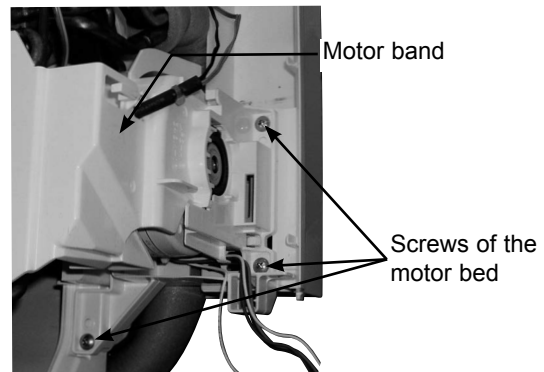
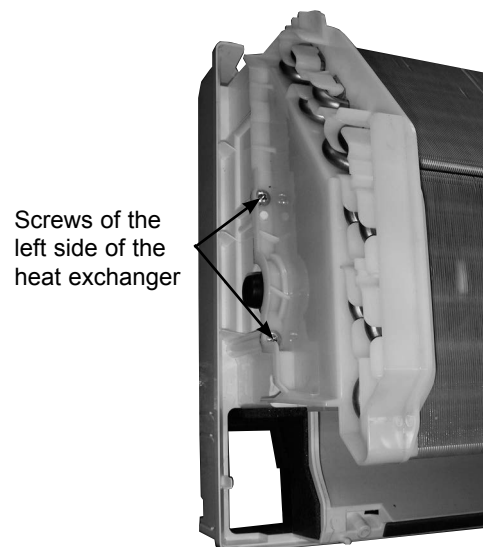
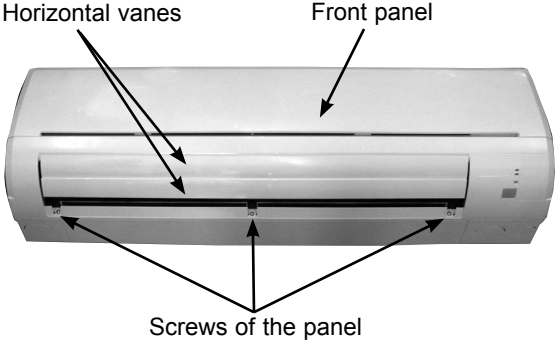
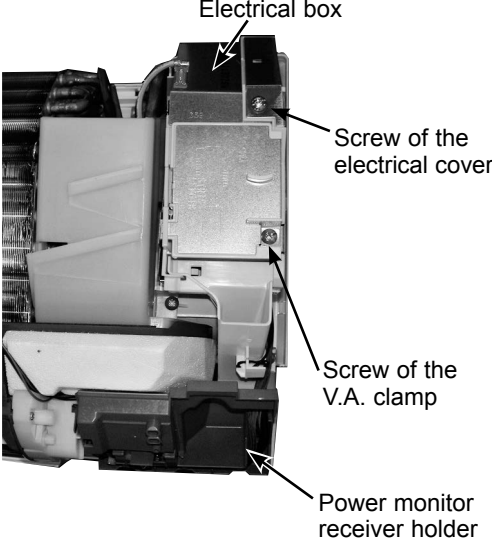
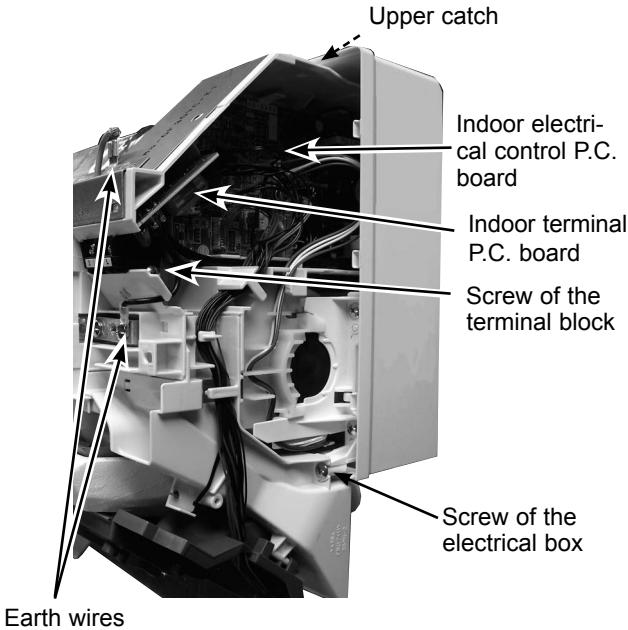

Photo 7



11-2. MS-GF50VA MS-GF60VA MS-GF80VA

NOTE: Turn OFF power supply before disassembly.

OPERATING PROCEDURE	PHOTOS
<p>1. Removing the panel</p> <ol style="list-style-type: none"> (1) Remove the horizontal vanes. (2) Remove the screw caps of the panel. Remove the screws of the panel. (3) Hold the lower part of both ends of the panel and pull it slightly toward you, and then remove the panel by pushing it upward. 	<p>Photo 1</p> 
<p>2. Removing the indoor electronic control P.C. board, the power monitor receiver SW P.C. board and the indoor terminal P.C. board</p> <ol style="list-style-type: none"> (1) Remove the panel (Refer to 1.) and the corner box. (2) Remove the screw of the V.A. clamp. Remove the V.A. clamp and the indoor/outdoor connecting wire. (Photo 2) (3) Remove the screw of the electrical cover, and then the electrical cover. (4) Remove the earth wire connected to the indoor electronic control P.C. board from the electrical box. (Photo 3) (5) Remove the power monitor receiver holder. (6) Open the rear cover of the power monitor receiver holder and pull out the power monitor receiver SW P.C. board. (7) Disconnect all the connectors on the indoor electronic control P.C. board and unhook all lead wires. (8) Remove the screw of the terminal block on the indoor terminal P.C. board. (9) Remove the indoor terminal P.C. board and the indoor electronic control P.C. board. 	<p>Photo 2</p> 
<p>3. Removing the indoor electrical box</p> <ol style="list-style-type: none"> (1) Remove the panel (Refer to 1.) and the corner box. (2) Remove the indoor/outdoor connecting wire. (Refer to 2.) (3) Remove the earth wire connected to the indoor heat exchanger from the electrical box. (4) Remove the screw of the electrical cover and remove the electrical cover. (5) Disconnect all the connectors on the indoor electronic control P.C. board and unhook all lead wires. (6) Remove the screw fixing the electrical box, then the upper catch of the electrical box, and pull out the electrical box. 	<p>Photo 3</p> 

OPERATING PROCEDURE

4. Removing the nozzle assembly

- (1) Remove the panel (Refer to 1.) and the corner box.
- (2) Remove the V.A. clamp, and then the indoor/outdoor connecting wire. (Photo 2)
- (3) Remove the electrical cover. (Photo 2)
- (4) Disconnect the following connectors on the electronic control P.C. board:
 - CN151 (Horizontal vane motor)
 - CN152 (Vertical vane motor)
- (5) Remove the power monitor receiver holder. (Photo 4)
- (6) Pull out the drain hose from the nozzle assembly and remove the nozzle assembly.
- (7) Remove the vane motors. (Refer to 5 and 6.)
- (8) Remove the interlock switch.

5. Removing the vertical vane motor unit

- (1) Remove the nozzle assembly. (Refer to 4.)
- (2) Remove the crank of the vertical vane motor unit from the arm of the vertical vane.
- (3) Remove the screw of the vertical vane motor unit, and pull the vertical vane motor unit.
- (4) Remove the screws of the vertical vane motor unit cover.
- (5) Remove the crank of the vertical vane motor unit from the shaft of the vane motor.
- (6) Remove the vertical vane motor from the vertical vane motor unit.
- (7) Disconnect the connector of vertical vane motor from the vertical vane motor.

6. Removing the horizontal vane motor

- (1) Remove the nozzle assembly. (Refer to 4.)
- (2) Remove the screws of the horizontal vane motor unit, and pull out the horizontal vane motor unit.
- (3) Disconnect the connector from the horizontal vane motor.
- (4) Remove the screws of the horizontal vane motor unit cover.
- (5) Remove the horizontal vane motor from the horizontal vane motor unit.

PHOTOS

Photo 4

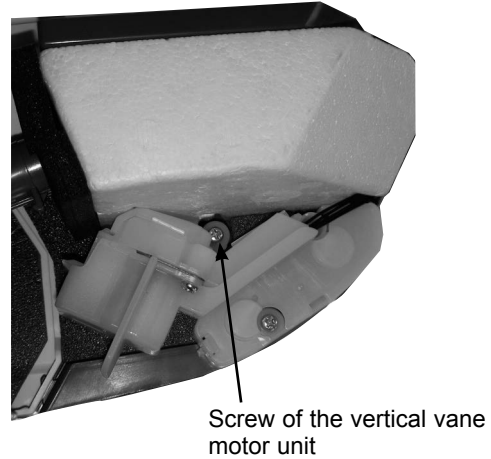

Photo 5

Screws of vertical vane motor unit cover

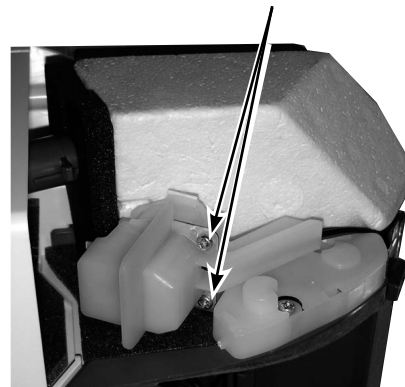
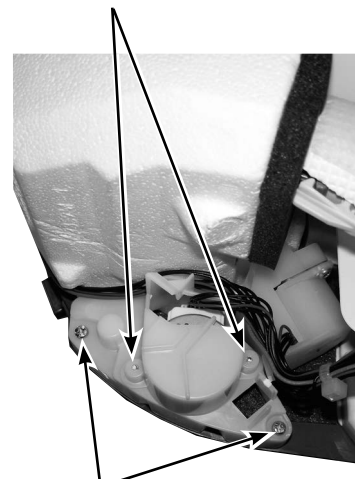

Photo 6

Screws of horizontal vane motor unit cover



Screws of horizontal vane motor unit

OPERATING PROCEDURE

7. Removing the water cut, the indoor fan motor, the indoor coil thermistor, and the line flow fan

- (1) Remove the panel (Refer to 1.) and the corner box.
- (2) Remove the power monitor receiver holder, the electrical box and the nozzle assembly. (Refer to 3 and 4.)
- (3) Remove the screw of the water cut and remove the water cut.
- (4) Remove the screws fixing the motor bed.
- (5) Loosen the screw fixing the line flow fan.
- (6) Remove the motor bed together with fan motor and motor band.
- (7) Remove the screw of the motor band.
- (8) Release the hooks of the motor band. Remove the motor band. Pull out the indoor fan motor.
- (9) Remove the indoor coil thermistor from the heat exchanger.
 ※Install the indoor coil thermistor in its former position when assembling it. (Photo 9)
- (10) Remove the screws fixing the left side of the heat exchanger.
- (11) Lift the heat exchanger, and pull out the line flow fan to the lower-left.

Photo 7

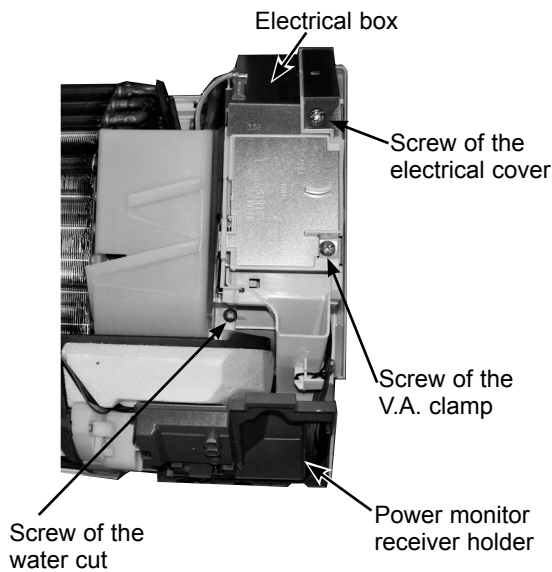

PHOTOS

Photo 8

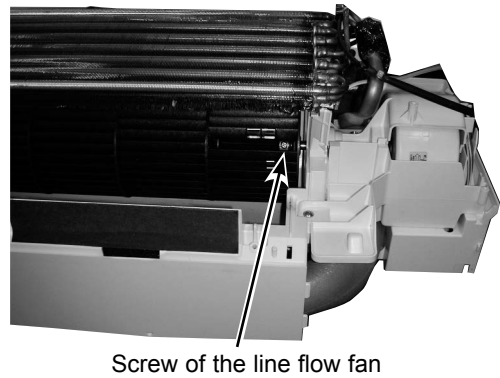

Photo 9

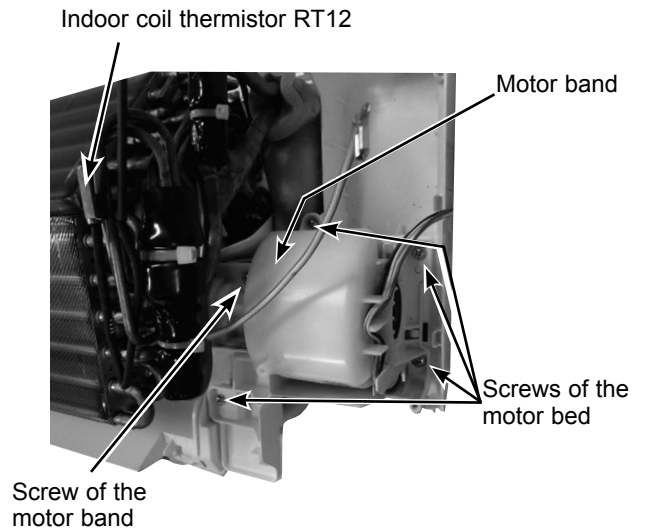
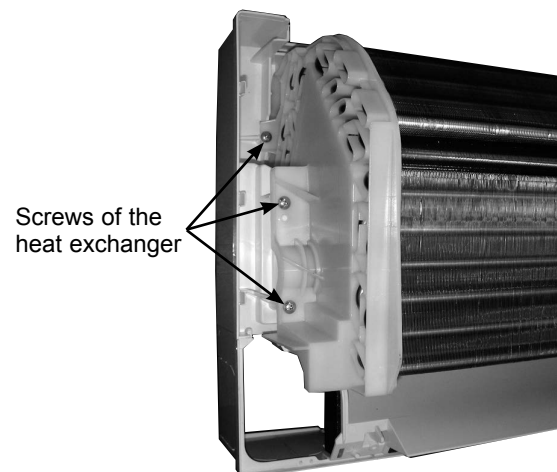

Photo 10



MITSUBISHI ELECTRIC CORPORATION

HEAD OFFICE: TOKYO BLDG., 2-7-3, MARUNOUCHI, CHIYODA-KU, TOKYO 100-8310, JAPAN

© Copyright 2012 MITSUBISHI ELECTRIC CORPORATION
Distributed in Feb. 2013. No. OBH621 REVISED EDITION-A
Distributed in Oct. 2012. No. OBH621
Made in Japan

New publication, effective Feb. 2013
Specifications are subject to change without notice.