

Air-Conditioners

Indoor unit

Кондиционеры

ВНУТРЕННИЙ БЛОК

SLZ-KF25, KF35, KF50, KF60VA



OPERATION MANUAL

FOR USER

For safe and correct use, please read this operation manual thoroughly before operating the air-conditioner unit.

BEDIENUNGSHANDBUCH

FÜR BENUTZER

Zum sicheren und einwandfreien Gebrauch der Klimaanlage dieses Bedienungshandbuch vor Inbetriebnahme gründlich durchlesen.

MANUEL D'UTILISATION

POUR L'UTILISATEUR

Pour une utilisation correcte sans risques, veuillez lire le manuel d'utilisation en entier avant de vous servir du climatiseur.

BEDIENINGSHANDLEIDING

VOOR DE GEBRUIKER

Voor een veilig en juist gebruik moet u deze bedieningshandleiding grondig doorlezen voordat u de airconditioner gebruikt.

MANUAL DE INSTRUCCIONES

PARA EL USUARIO

Lea este manual de instrucciones hasta el final antes de poner en marcha la unidad de aire acondicionado para garantizar un uso seguro y correcto.

ISTRUZIONI DI FUNZIONAMENTO

PER L'UTENTE

Leggere attentamente questi istruzioni di funzionamento prima di avviare l'unità, per un uso corretto e sicuro della stessa.

ΕΓΧΕΙΡΙΔΙΟ ΟΔΗΓΙΩΝ ΧΡΗΣΕΩΣ

ΓΙΑ ΤΟΝ ΧΡΗΣΤΗ

Για ασφάλεια και σωστή χρήση, παρακαλείστε διαβάσετε προσεκτικά αυτό το εγχειρίδιο χρήσεως πριν θέσετε σε λειτουργία τη μονάδα κλιματισμού.

MANUAL DE OPERAÇÃO

PARA O UTILIZADOR

Para segurança e utilização correctas, leia atentamente o manual de operação antes de pôr a funcionar a unidade de ar condicionado.

DRIFTSMANUAL

TIL BRUGER

Læs venligst denne driftsmanual grundigt før airconditionanlægget betjenes af hensyn til sikker og korrekt brug.

DRIFTSMANUAL

FÖR ANVÄNDAREN

Läs denna driftsmanual noga för säkert och korrekt bruk innan luftkonditioneringen används.

İşletme Elkitabı

KULLANICI İÇİN

Emniyetli ve doğru biçimde nasıl kullanılacağını öğrenmek için lütfen klima cihazını işletmeden önce bu elkitabını dikkatle okuyunuz.

РУКОВОДСТВО ПО ЭКСПЛУАТАЦИИ

ДЛЯ ПОЛЬЗОВАТЕЛЯ

Для обеспечения правильного и безопасного использования следует ознакомиться с инструкциями, указанными в данном руководстве по эксплуатации, тщательным образом до того, как приступить к использованию кондиционера.

English

Deutsch

Français

Nederlands

Español

Italiano

Ελληνικά

Português

Dansk

Svenska

Türkçe

Русский

Contents

1. Safety Precautions	2	5. Care and Cleaning.....	12
2. Parts Names.....	3	6. Trouble Shooting	13
3. Operation	6	7. Installation, relocation and inspection.....	14
4. Timer.....	11	8. Specifications	15

Note



Fig. 1

This symbol mark is for EU countries only.

This symbol mark is according to the directive 2012/19/EU Article 14 Information for users and Annex IX, and/or to the directive 2006/66/EC Article 20 Information for end-users and Annex II.

Your MITSUBISHI ELECTRIC product is designed and manufactured with high quality materials and components which can be recycled and/or reused. This symbol means that electrical and electronic equipment, batteries and accumulators, at their end-of-life, should be disposed of separately from your household waste. If a chemical symbol is printed beneath the symbol (Fig. 1), this chemical symbol means that the battery or accumulator contains a heavy metal at a certain concentration.

This will be indicated as follows: Hg: mercury (0,0005%), Cd: cadmium (0,002%), Pb: lead (0,004%)

In the European Union there are separate collection systems for used electrical and electronic products, batteries and accumulators.

Please, dispose of this equipment, batteries and accumulators correctly at your local community waste collection/recycling centre.

Please, help us to conserve the environment we live in!

Note:

The phrase "Wired remote controller" in this operation manual refers only to the PAR-32MAA. If you need any information for the other remote controller, please refer to the instruction book included in this box.

1. Safety Precautions

- ▶ Before installing the unit, make sure you read all the "Safety Precautions".
- ▶ The "Safety Precautions" provide very important points regarding safety. Make sure you follow them.
- ▶ Please report to or take consent by the supply authority before connection to the system.

Symbols used in the text

⚠ Warning:

Describes precautions that should be observed to prevent danger of injury or death to the user.

⚠ Caution:

Describes precautions that should be observed to prevent damage to the unit.

Symbols used in the illustrations

⚡ : Indicates a part which must be grounded.

⚠ Warning:

- These appliances are not accessible to the general public.
- The unit must not be installed by the user. Ask the dealer or an authorized company to install the unit. If the unit is installed improperly, water leakage, electric shock or fire may result.
- Do not stand on, or place any items on the unit.
- Do not splash water over the unit and do not touch the unit with wet hands. An electric shock may result.
- Do not spray combustible gas close to the unit. Fire may result.
- Do not place a gas heater or any other open-flame appliance where it will be exposed to the air discharged from the unit. Incomplete combustion may result.
- Do not remove the front panel or the fan guard from the outdoor unit when it is running.
- When you notice exceptionally abnormal noise or vibration, stop operation, turn off the power switch, and contact your dealer.
- Never insert fingers, sticks etc. into the intakes or outlets.
- If you detect odd smells, stop using the unit, turn off the power switch and consult your dealer. Otherwise, a breakdown, electric shock or fire may result.
- This air conditioner is NOT intended for use by children or infirm persons without supervision.
- Young children must be supervised to ensure that they do not play with the air conditioner.
- If the refrigeration gas blows out or leaks, stop the operation of the air conditioner, thoroughly ventilate the room, and contact your dealer.

- This appliance is intended to be used by expert or trained users in shops, in light industry and on farms, or for commercial use by lay persons.
- This appliance can be used by children aged from 8 years and above and persons with reduced physical, sensory or mental capabilities or lack of experience and knowledge if they have been given supervision or instruction concerning use of the appliance in a safe way and understand the hazards involved. Children shall not play with the appliance. Cleaning and user maintenance shall not be made by children without supervision.
- This appliance is not intended for use by persons (including children) with reduced physical, sensory or mental capabilities, or lack of experience and knowledge, unless they have been given supervision or instruction concerning use of the appliance by a person responsible for their safety.
- When installing or relocating, or servicing the air conditioner, use only the specified refrigerant (R410A) to charge the refrigerant lines. Do not mix it with any other refrigerant and do not allow air to remain in the lines.

If air is mixed with the refrigerant, then it can be the cause of abnormal high pressure in the refrigerant line, and may result in an explosion and other hazards.

The use of any refrigerant other than that specified for the system will cause mechanical failure or system malfunction or unit breakdown. In the worst case, this could lead to a serious impediment to securing product safety.

⚠ Caution:

- Do not use any sharp object to push the buttons, as this may damage the remote controller.
- Never block or cover the indoor or outdoor unit's intakes or outlets.

Disposing of the unit

When you need to dispose of the unit, consult your dealer.

2. Parts Names

Indoor Unit

	SLZ-KF-VA
Fan steps	3 steps
Vane	Auto with swing
Louver	—
Filter	Long-life
Filter cleaning indication	2,500 hr

SLZ-KF-VA

4-way Ceiling Cassette

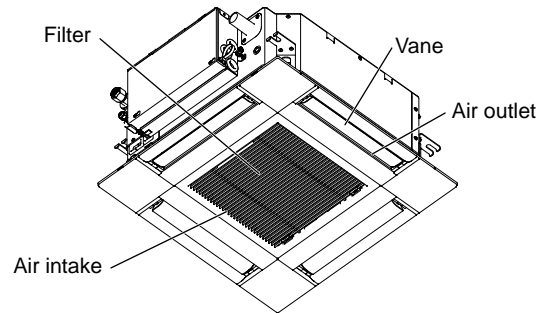

Wired Remote Controller

Controller interface

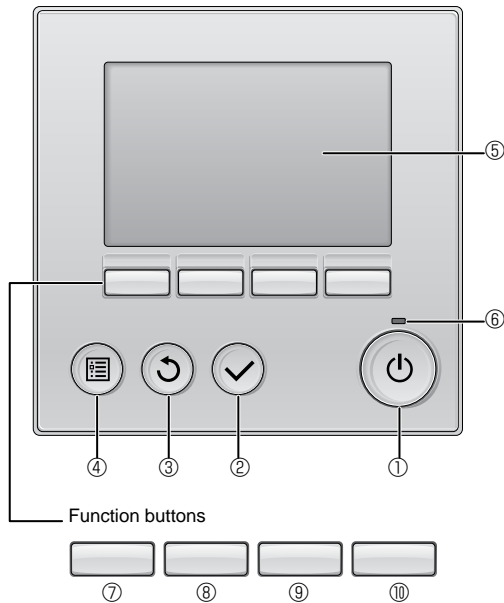

The functions of the function buttons change depending on the screen.

Refer to the button function guide that appears at the bottom of the LCD for the functions they serve on a given screen.

When the system is centrally controlled, the button function guide that corresponds to the locked button will not appear.

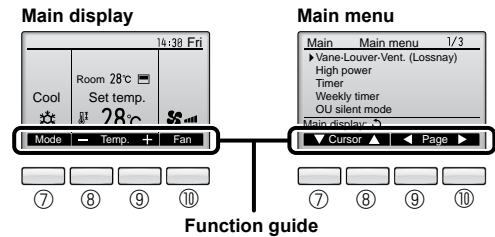

① [ON/OFF] button

Press to turn ON/OFF the indoor unit.

② [SELECT] button

Press to save the setting.

③ [RETURN] button

Press to return to the previous screen.

④ [MENU] button

Press to bring up the Main menu.

⑤ Backlit LCD

Operation settings will appear.

When the backlight is off, pressing any button turns the backlight on and it will stay lit for a certain period of time depending on the screen.

When the backlight is off, pressing any button turns the backlight on and does not perform its function. (except for the [ON/OFF] button)

⑥ ON/OFF lamp

This lamp lights up in green while the unit is in operation. It blinks while the remote controller is starting up or when there is an error.

⑦ Function button [F1]

Main display: Press to change the operation mode.

Main menu: Press to move the cursor down.

⑧ Function button [F2]

Main display: Press to decrease temperature.

Main menu: Press to move the cursor up.

⑨ Function button [F3]

Main display: Press to increase temperature.

Main menu: Press to go to the previous page.

⑩ Function button [F4]

Main display: Press to change the fan speed.

Main menu: Press to go to the next page.

2. Parts Names

Display

The main display can be displayed in two different modes: "Full" and "Basic". The factory setting is "Full". To switch to the "Basic" mode, change the setting on the Main display setting. (Refer to operation manual included with remote controller.)

<Full mode>

* All icons are displayed for explanation.

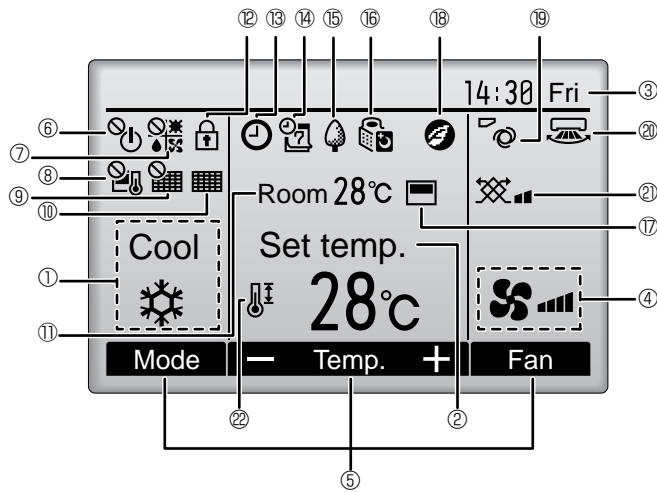

<Basic mode>

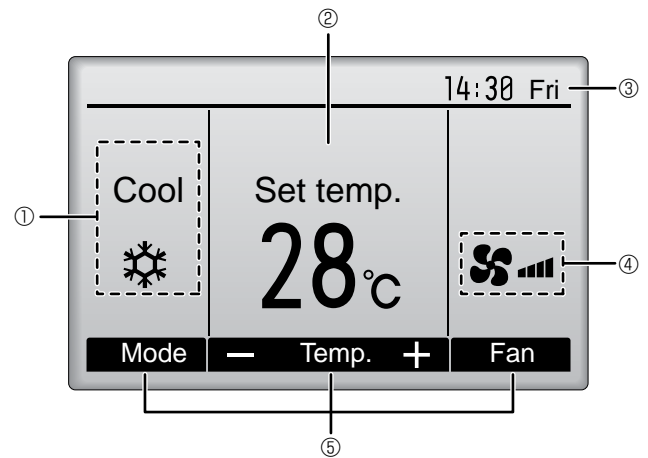

① Operation mode

Indoor unit operation mode appears here.

② Preset temperature

Preset temperature appears here.

③ Clock (See the Installation Manual.)

Current time appears here.

④ Fan speed

Fan speed setting appears here.

⑤ Button function guide

Functions of the corresponding buttons appear here.



Appears when the ON/OFF operation is centrally controlled.



Appears when the operation mode is centrally controlled.



Appears when the preset temperature is centrally controlled.



Appears when the filter reset function is centrally controlled.



Indicates when filter needs maintenance.

⑪ Room temperature (See the Installation Manual.)

Current room temperature appears here.



Appears when the buttons are locked.



Appears when the On/Off timer, Night setback, or Auto-off timer function is enabled.



Appears when the timer is disabled by the centralized control system.



Appears when the Weekly timer is enabled.



Appears while the units are operated in the energy-save mode. (Will not appear on some models of indoor units)



Appears while the outdoor units are operated in the silent mode.



Appears when the built-in thermistor on the remote controller is activated to monitor the room temperature (⑪).



Appears when the thermistor on the indoor unit is activated to monitor the room temperature.



Appears when the units are operated in the energy-save mode with 3D i-See sensor.



Indicates the vane setting.



Indicates the louver setting.



Indicates the ventilation setting.



Appears when the preset temperature range is restricted.

Most settings (except ON/OFF, mode, fan speed, temperature) can be made from the Menu screen. (Refer to operation manual included with remote controller.)

2. Parts Names

■ Wireless Remote-Controller

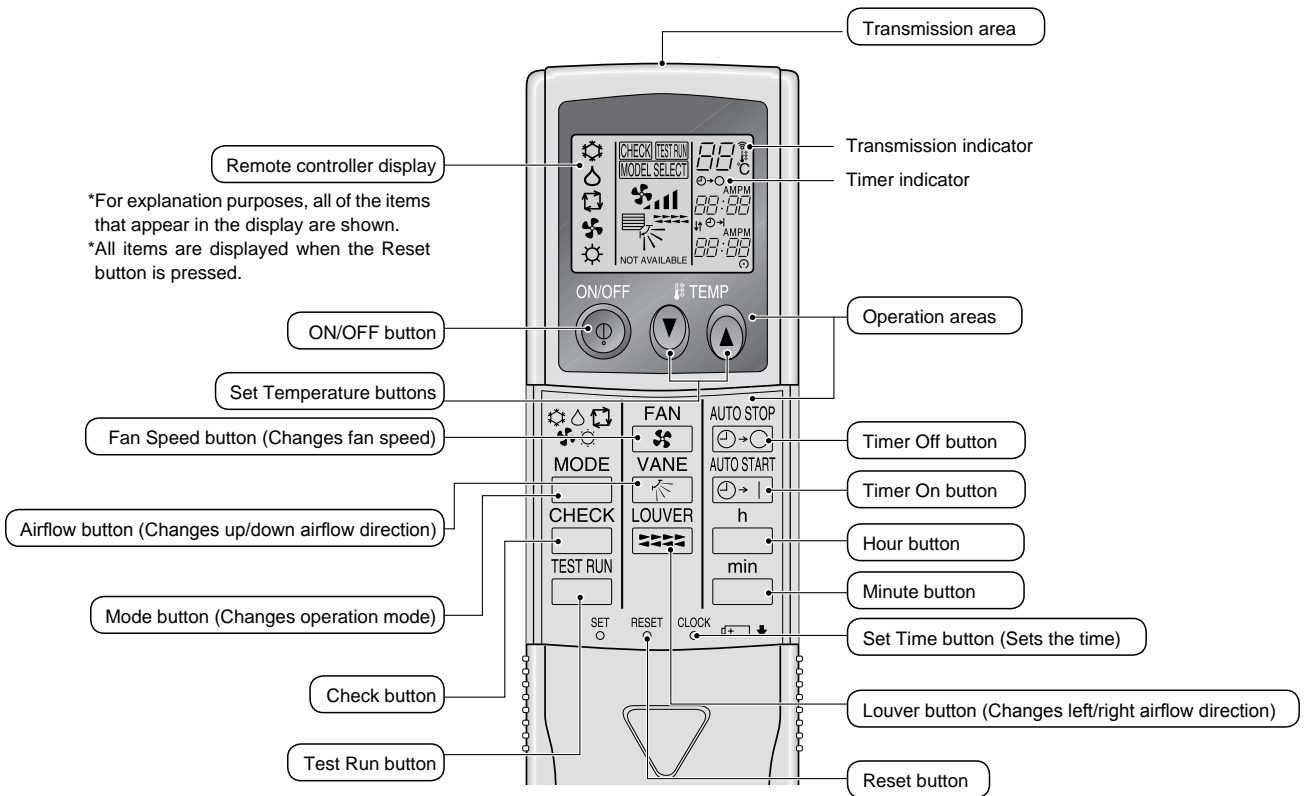

Note (Only for wireless remote controller):

- When using the wireless remote controller, point it towards the receiver on the indoor unit.
- If the remote controller is operated within approximately 2 minutes after power is supplied to the indoor unit, the indoor unit may beep twice as the unit is performing the initial automatic check.
- The indoor unit beeps to confirm that the signal transmitted from the remote controller has been received. Signals can be received up to approximately 7 meters in a direct line from the indoor unit in an area 45° to the left and right of the unit. However, illumination such as fluorescent lights and strong light can affect the ability of the indoor unit to receive signals.
- If the operation lamp near the receiver on the indoor unit is blinking, the unit needs to be inspected. Consult your dealer for service.
- Handle the remote controller carefully! Do not drop the remote controller or subject it to strong shocks. In addition, do not get the remote controller wet or leave it in a location with high humidity.
- To avoid misplacing the remote controller, install the holder included with the remote controller on a wall and be sure to always place the remote controller in the holder after use.

■ Outdoor unit

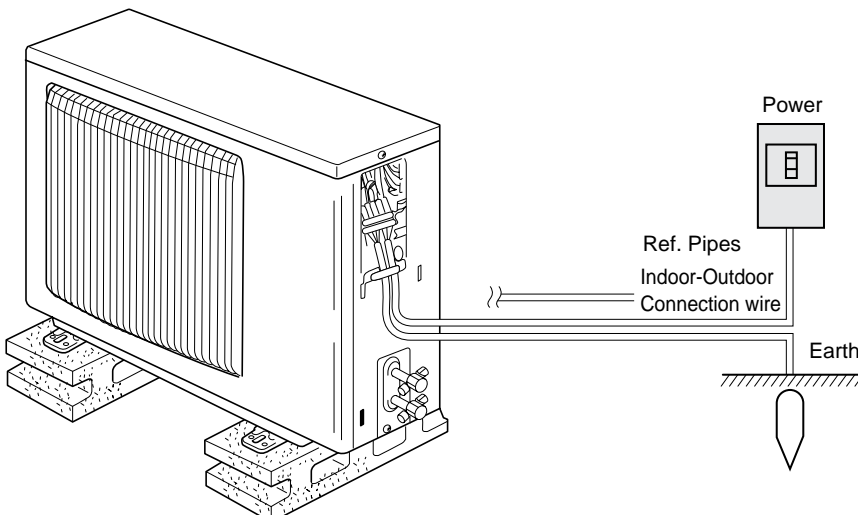

Battery installation/replacement

1. Remove the top cover, insert 2 AAA batteries, and then install the top cover.

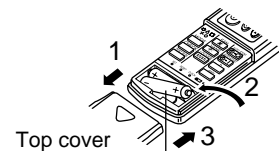

Two AAA batteries
Insert the negative (-)
end of each battery first.
Install the batteries in the
correct directions
(+, -)!

2. Press the Reset button.

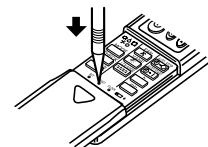

Press the Reset button
with an object that has a
narrow end.

3. Operation

■ About the operation method, refer to the operation manual that comes with each remote controller.

3.1. Turning ON/OFF

[ON]

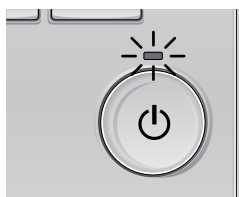

Press the [ON/OFF] button.
The ON/OFF lamp will light up in green, and the operation will start.

[OFF]

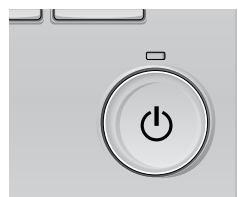

Press the [ON/OFF] button again.
The ON/OFF lamp will come off, and the operation will stop.

Note:

Even if you press the ON/OFF button immediately after shutting down the operation is progress, the air conditioner will not start for about 3 minutes.

This is to prevent the internal components from being damaged.

■ Operation status memory

	Remote controller setting
Operation mode	Operation mode before the power was turned off
Preset temperature	Preset temperature before the power was turned off
Fan speed	Fan speed before the power was turned off

■ Settable preset temperature range

Operation mode	Preset temperature range
Cool/Dry	19 – 30 °C
Heat	17 – 28 °C
Auto	19 – 28 °C
Fan/Ventilation	Not settable

3.2. Mode Selection

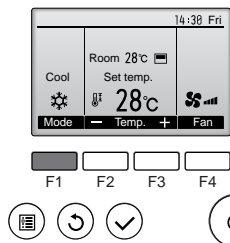

Press the [F1] button to go through the operation modes in the order of "Cool", "Dry", "Fan", "Auto", and "Heat". Select the desired operation mode.

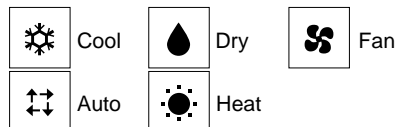

- Operation modes that are not available to the connected indoor unit models will not appear on the display.

- In the heating operation, though indoor unit that does not operate may get warm or the sound of refrigerant flowing may be heard, they are not malfunction. The reason is that the refrigerant continuously flows into it.

Automatic operation

- According to a set temperature, cooling operation starts if the room temperature is too hot and heating operation starts if the room temperature is too cold.
- During automatic operation, if the room temperature changes and remains 2 °C or more above the set temperature for 15 minutes, the air conditioner switches to cooling mode. In the same way, if the room temperature remains 2 °C or more below the set temperature for 15 minutes, the air conditioner switches to heating mode.

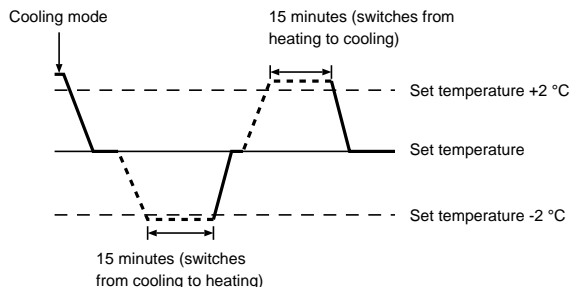

What the blinking mode icon means
The mode icon will blink when other indoor units in the same refrigerant system (connected to the same outdoor unit) are already operated in a different mode. In this case, the rest of the unit in the same group can only be operated in the same mode.

Information for multi system air conditioner (Outdoor unit: MXZ series)

▶ Multi system air conditioner (Outdoor unit: MXZ series) can connect two or more indoor units with one outdoor unit. According to the capacity, 2 or more units can operate simultaneously.

- When you try to operate 2 or more indoor units with 1 outdoor unit simultaneously, one for the cooling and the other for heating, the operation mode of the indoor unit that operates earlier is selected. The other indoor units that will start the operation later cannot operate, indicating an operation state in blinking. In this case, please set all the indoor units to the same operation mode.
- There might be a case that the indoor unit, which is operating in "Auto" mode. Cannot change over to the operating mode "Cool"/"Heat" and becomes a state of standby.
- When indoor unit starts the operation while the defrosting of outdoor unit is being done, it takes a few minutes (max. about 15 minutes) to blow out the warm air.

3. Operation

3.3. Temperature setting

<Cool, Dry, Heat, and Auto>

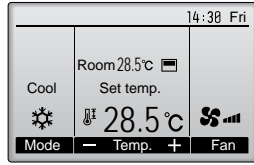
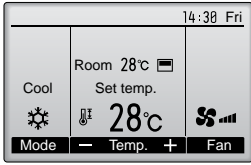

Example display
(Centigrade in 0.5-degree increments)

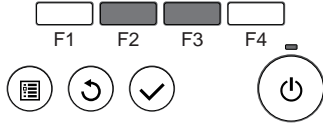

Press the [F2] button to decrease the preset temperature, and press the [F3] button to increase.

- Refer to the table on page 6 for the settable temperature range for different operation modes.
- Preset temperature range cannot be set for Fan/Ventilation operation.
- Preset temperature will be displayed either in Centigrade in 0.5- or 1-degree increments, or in Fahrenheit, depending on the indoor unit model and the display mode setting on the remote controller.

3.4. Fan speed setting

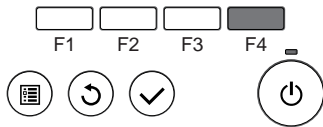
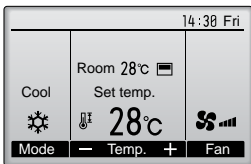

Press the [F4] button to go through the fan speeds in the following order.

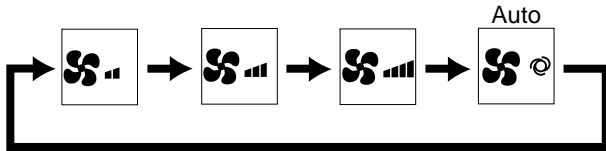

- The available fan speeds depend on the models of connected indoor units.

Note:

- The number of available fan speeds depends on the type of unit connected.
- In the following cases, the actual fan speed generated by the unit will differ from the speed shown the remote controller display.
 1. While the display is in "STAND BY" or "DEFROST" states.
 2. When the temperature of the heat exchanger is low in the heating mode.
(e.g. immediately after heating operation starts)
 3. In HEAT mode, when room temperature is higher than the temperature setting.
 4. When the unit is in DRY mode.

3.5. Airflow direction setting

3.5.1 Navigating through the Main menu

<Accessing the Main menu>

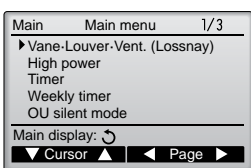

Press the [MENU] button.
The Main menu will appear.

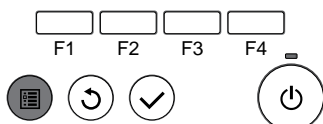

<Item selection>

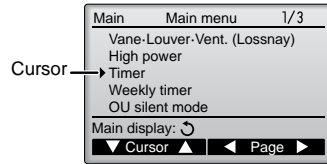

Press [F1] to move the cursor down.
Press [F2] to move the cursor up.

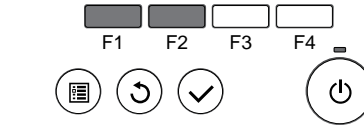

<Navigating through the pages>

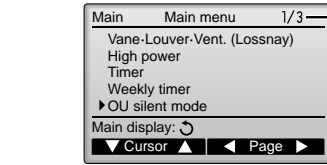

Press [F3] to go to the previous page.
Press [F4] to go to the next page.

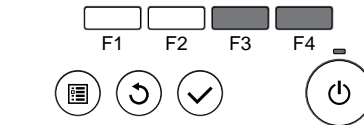

<Saving the settings>

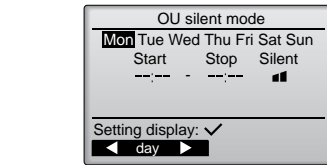

Select the desired item, and press the [SELECT] button.

The screen to set the selected item will appear.

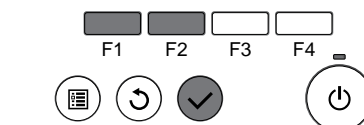

<Exiting the Main menu screen>

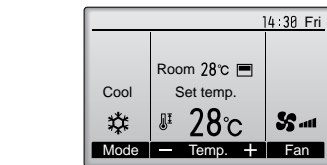

Press the [RETURN] button to exit the Main menu and return to the Main display.

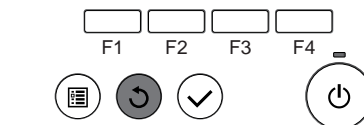

If no buttons are touched for 10 minutes, the screen will automatically return to the Main display. Any settings that have not been saved will be lost.

<Display of unsupported functions>



The message at left will appear if the user selects a function not supported by the corresponding indoor unit model.

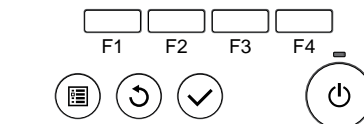

3. Operation

3.5.2 Vane-Vent. (Lossnay)

<Accessing the menu>

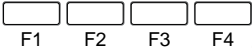
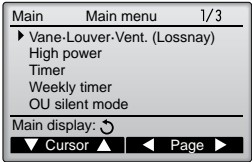

Select "Vane-Louver-Vent. (Lossnay)" from the Main menu (refer to page 7), and press the [SELECT] button.

<Vane setting>

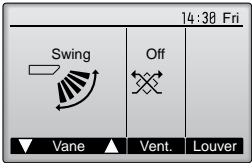

Press the [F1] or [F2] button to go through the vane setting options: "Step 1", "Step 2", "Step 3", "Step 4", "Step 5", "Swing" and "Auto". Select the desired setting.

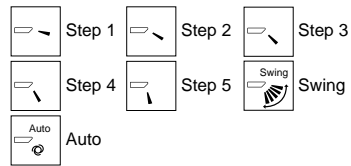

Select "Swing" to move the vanes up and down automatically. When set to "Step 1" through "Step 5", the vane will be fixed at the selected angle.

<Vent. setting>

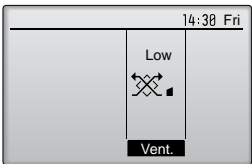

Press the [F3] button to go through the ventilation setting options in the order of "Off", "Low", and "High". * Settable only when LOSSNAY unit is connected.

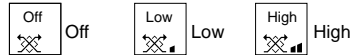

The fan on some models of indoor units may be interlocked with certain models of ventilation units.

<Returning to the Main menu>

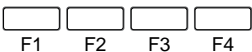
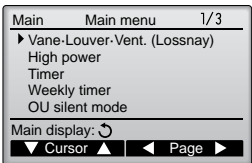

Press the [RETURN] button to go back to the Main menu.

Note:

- During swing operation, the directional indication on the screen does not change in sync with the directional vanes on the unit.
- Available directions depend on the type of unit connected.
- In the following cases, the actual air direction will differ from the direction indicated on the remote controller display.
 1. While the display is in "STAND BY" or "DEFROST" states.
 2. Immediately after starting heat mode (while the system is waiting for the mode change to take effect).
 3. In heat mode, when room temperature is higher than the temperature setting.

< How to set the fixed up/down air direction (Only for wired remote controller) >

Note:

- This function cannot be set depending on the outdoor unit to be connected.
- For SLZ-KF-VA series, only the particular outlet can be fixed to certain direction with the procedures below. Once fixed, only the set outlet is fixed every time air conditioner is turned on. (Other outlets follow UP/DOWN air direction setting of remote controller.)
- Explanation of word
 - "Refrigerant address No." and "Unit No." are the numbers given to each air conditioner.
 - "Outlet No." is the number given to each outlet of air conditioner. (Refer to the illustration below.)
 - "Up/Down air direction" is the direction (angle) to fix.

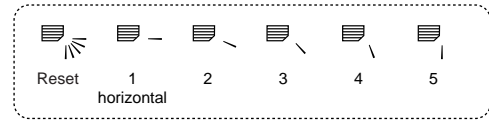

Remote controller setting

The airflow direction of this outlet is controlled by the airflow direction setting of remote controller.

Fixed

The airflow direction of this outlet is fixed in particular direction.

* When it is cold because of direct airflow, the airflow direction can be fixed horizontally to avoid direct airflow.

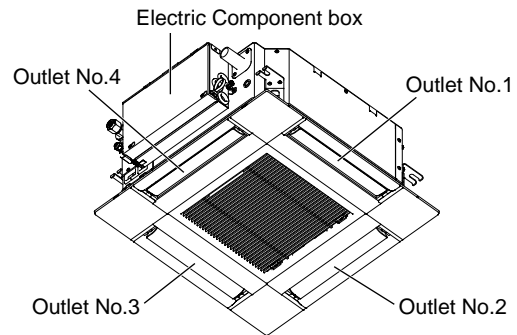

Note:

The outlet No. is indicated by the number of grooves on both ends of each air outlet. Set the air direction while checking the information shown on the remote controller display.

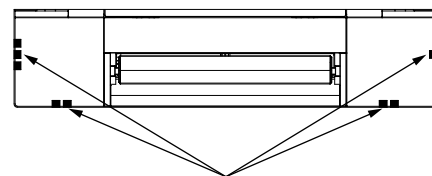

Air outlet identification marks

3. Operation

Manual vane angle

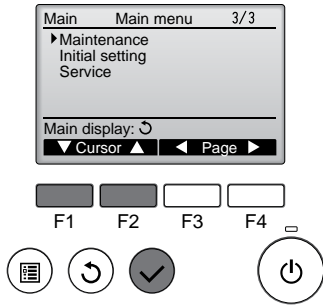

① Select "Maintenance" from the Main menu (refer to page 7), and press the [SELECT] button.

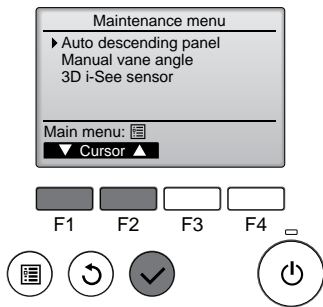

② Select "Manual vane angle" with the [F1] or [F2] button, and press the [SELECT] button.

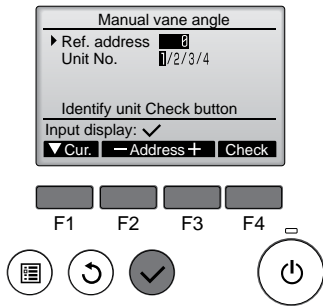

③ Move the cursor to "Ref. address" or "Unit No." with the [F1] button to select.
 Select the refrigerant address and the unit number for the units to whose vanes are to be fixed, with the [F2] or [F3] button, and press the [SELECT] button.

- Ref. address: Refrigerant address
- Unit No.: 1, 2, 3, 4

Press the [F4] button to confirm the unit.
 The vane of only the target indoor unit is pointing downward.

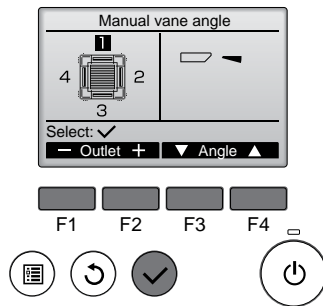

④ The current vane setting will appear.

Select the desired outlets from 1 through 4 with the [F1] or [F2] button.

- Outlet: "1", "2", "3", "4" and "1, 2, 3, 4, (all outlets)"

Press the [F3] or [F4] button to go through the option in the order of "No setting (reset)," "Step 1", "Step 2", "Step 3", "Step 4", "Step 5" and "Draft reduction*".
 Select the desired setting.

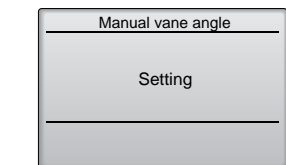

Note:
 Do not set the draft reduction in an environment with high humidity. Otherwise, condensation may form and drip.

* Draft reduction
 The airflow direction for this setting is more horizontal than the airflow direction for the "Step 1" setting in order to reduce a drafty feeling. The draft reduction can be set for only 1 vane.

Vane setting

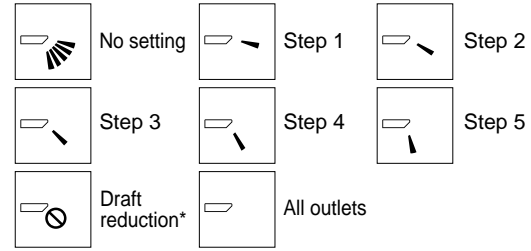

Press the [SELECT] button to save the settings.
 A screen will appear that indicates the setting information is being transmitted.
 The setting changes will be made to the selected outlet.
 The screen will automatically return to the one shown above (step 5) when the transmission is completed.
 Make the settings for other outlets, following the same procedures.

If all outlets are selected, [icon] will be displayed the next time the unit goes into operation.

Navigating through the screens
 • To go back to the Main menu..... [MENU] button
 • To return to the previous screen [RETURN] button

Confirmation procedure

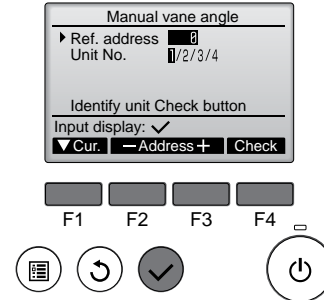

① First, confirm by setting "Ref. address" to 0 and "Unit No." to 1.

- Move the cursor to "Ref. address" or "Unit No." with the [F1] button to select.
- Select the refrigerant address and the unit number for the units to whose vanes are to be fixed, with the [F2] or [F3] button, and press the [SELECT] button.
- Ref. address: Refrigerant address
- Unit No.: 1, 2, 3, 4

Press the [F4] button to confirm the unit.

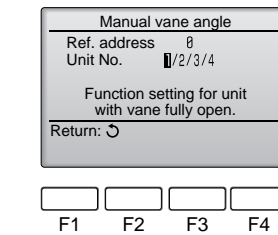

② Change the "Unit No." in order and check each unit.

- Press the [F1] button to select "Unit No.".
- Press the [F2] or [F3] button to change the "Unit No." to the unit that you want to check, and then press the [F4] button.
- After pressing the [F4] button, wait approximately 15 seconds, and then check the current state of the air conditioner.
 - The vane is pointing downward.
 - This air conditioner is displayed on the remote controller.
 - All outlets are closed. → Press the [RETURN] button and continue the operation from the beginning.
 - The messages shown to the left are displayed. → The target device does not exist at this refrigerant address.
- Press the [RETURN] button to return to the initial screen.

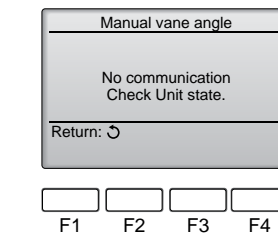

③ Change the "Ref. address" to the next number.

- Refer to step ① to change the "Ref. address" and continue with the confirmation.

3. Operation

3.6. 3D i-See sensor setting

3.6.1 3D i-See sensor setting

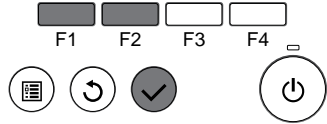
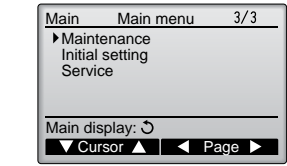

- ① Select "Maintenance" from the Main menu (refer to page 7), and press the [SELECT] button.

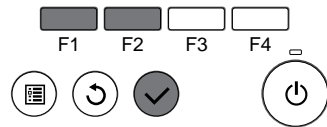
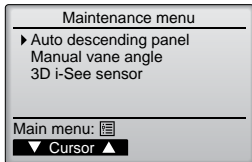

- ② Select "3D i-See sensor" with the [F1] or [F2] button, and press the [SELECT] button.

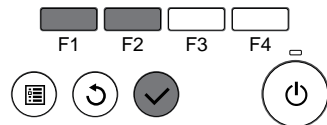
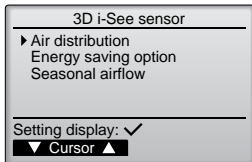

- ③ Select the desired menu with the [F1] or [F2] button, and press the [SELECT] button.

- Air distribution
Select the airflow direction control method when the airflow direction is set to "Auto".
- Energy saving option
Operates the energy-save mode according to whether persons are detected in the room by the 3D i-See sensor.
- Seasonal airflow
When the thermostat turns off, the fan and the vanes operate according to the control settings.

3.6.2 Air distribution

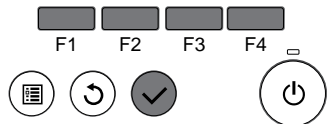
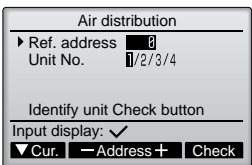

- ① Move the cursor to "Ref. address" or "Unit No." with the [F1] button to select.

Select the refrigerant address and the unit number for the units to whose vanes are to be fixed, with the [F2] or [F3] button, and press the [SELECT] button.

- Ref. address: Refrigerant address
- Unit No.: 1, 2, 3, 4
Press the [F4] button to confirm the unit.
The vane of only the target indoor unit is pointing downward.

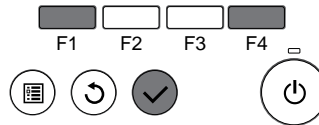
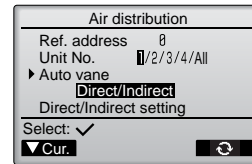

- ② Select the menu with the [F4] button.
Default → Area → Direct/Indirect → Default...

Default: The vanes move the same as during normal operation.

During cooling mode, all of the vanes move to the horizontal airflow direction.

During heating mode, all of the vanes move to the down airflow direction.

Area: The vanes move to the down airflow direction toward areas with a high floor temperature during cooling mode and toward areas with a low floor temperature during heating mode. Otherwise, the vanes move to the horizontal airflow direction.

Direct/Indirect: The vanes automatically move relative to the areas where persons are detected.

The vanes operate as indicated in the following table.

	Vane setting	
	Direct	Indirect
Cooling	horizontal → swing	keep horizontal
Heating	keep downward	downward → horizontal

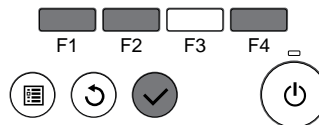
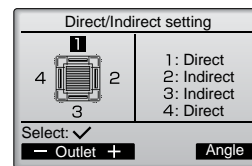

- ③ When Direct/Indirect is selected, set each air outlet.

Select the air outlet with the [F1] or [F2] button, and change the setting with the [F4] button.

After changing the settings for all of the air outlets, press the [SELECT] button to save the settings.

- * In order to enable this function, the airflow direction must be set to "Auto".

3.6.3 Energy saving option

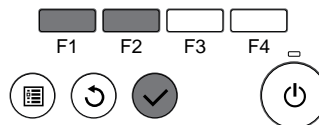
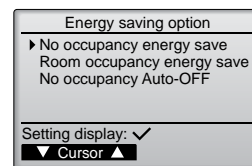

- ① Select the desired menu with the [F1] or [F2] button.

No occupancy energy save

If there are no persons in the room for 60 minutes or more, energy-saving operation equal to 2 °C is performed.

Room occupancy energy save
If the occupancy rate decreases to approximately 30% of the maximum occupancy rate, energy-saving operation equal to 1 °C is performed.

No occupancy Auto-OFF
If there are no persons in the room for the set amount of time (60–180 minutes), the operation is automatically stopped.

3. Operation

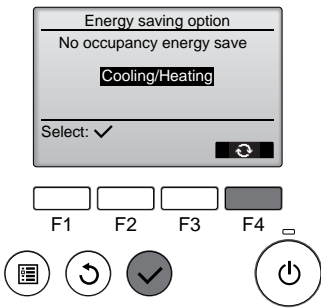

② When No occupancy energy save or Room occupancy energy save is selected

Select the setting with the [F4] button.
OFF → Cooling only → Heating only → Cooling/Heating → OFF...

After changing the setting, press the [SELECT] button to save the setting.

OFF: The function is disabled.
Cooling only: The function is enabled only during cooling mode.
Heating only: The function is enabled only during heating mode.
Cooling/Heating: The function is enabled during both cooling mode and heating mode.

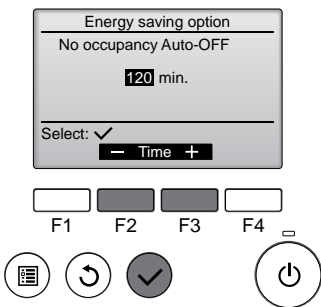
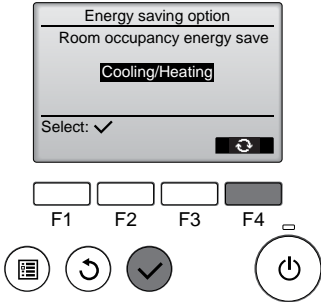

③ When No occupancy Auto-OFF is selected
Set the time with the [F3] or [F4] button.

---: The setting is disabled (the operation will not stop automatically).
60–180: The time can be set in 10-minute increments.

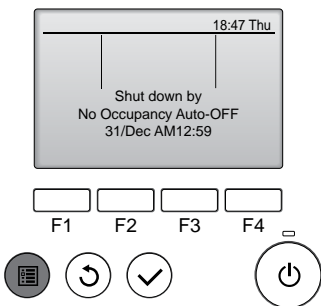

④ The message at left will appear if the operation was stopped automatically by the No occupancy Auto-OFF setting.

3.6.4 Seasonal airflow function

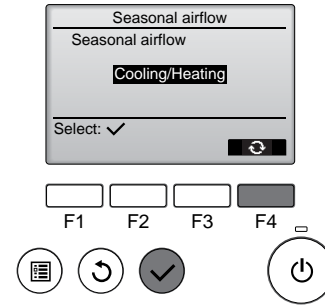

① Select the setting with the [F4] button.
OFF → Cooling only → Heating only → Cooling/Heating → OFF...

After changing the setting, press the [SELECT] button to save the setting.

OFF: The function is disabled.
Cooling only: When the thermostat turns off during cooling mode, the vanes move up and down.
Heating only: When the thermostat turns off during heating mode, the vanes move to the horizontal airflow direction to circulate the air.
Cooling/Heating: The function is enabled during both cooling mode and heating mode.

* In order to enable this function, the airflow direction must be set to "Auto".

Note:

Any person at the following places cannot be detected.

- Along the wall on which the air conditioner is installed
- Directly under the air conditioner
- Where any obstacle, such as furniture, is between the person and the air conditioner

A person may not be detected in the following situations.

- Room temperature is high.
- A person wears heavy clothes and his/her skin is not exposed.
- A heating element of which temperature changes significantly is present.
- Some heat sources, such as a small child or pet, may not be sensed.
- A heat source does not move for a long time.

The 3D i-See sensor operates once approximately every 3 minutes to measure the floor temperature and detect persons in the room.

- The intermittent operating sound is a normal sound produced when the 3D i-See sensor is moving.

3.7. Ventilation

For LOSSNAY combination

- The following 2 patterns of operation is available.
 - Run the ventilator together with indoor unit.
 - Run the ventilator independently.

Note: (for wireless remote controller)

- Running the ventilator independently is not available.
- No indication on the remote controller.

4. Timer

- Timer functions are different by each remote controller.
- For details on how to operate the remote controller, refer to the appropriate operation manual included with each remote controller.

5. Care and Cleaning

■ Filter information

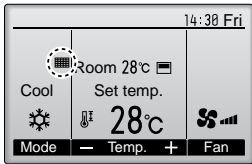

The  will appear on the Main display in the Full mode when it is time to clean the filters.

Wash, clean, or replace the filters when this sign appears. Refer to the indoor unit Instructions Manual for details.

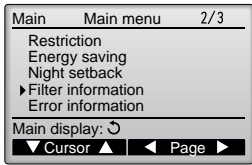

Select "Filter information" from the Main menu (refer to page 7), and press the [SELECT] button.

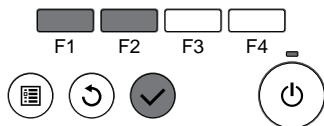

Press the [F4] button to reset filter sign. Refer to the indoor unit Instructions Manual for how to clean the filter.

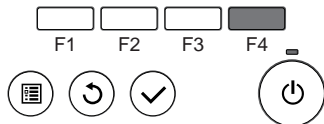

Select "OK" with the [F4] button.

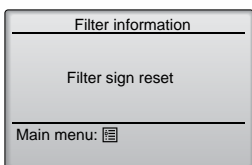
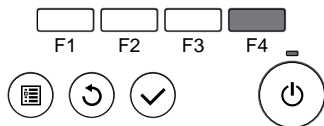

A confirmation screen will appear.

Navigating through the screens

- To go back to the Main menu [MENU] button
- To return to the previous screen [RETURN] button

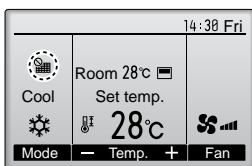

When the  is displayed on the Main display in the Full mode, the system is centrally controlled and the filter sign cannot be reset.

If two or more indoor units are connected, filter cleaning timing for each unit may be different, depending on the filter type.

The icon  will appear when the filter on the main unit is due for cleaning.

When the filter sign is reset, the cumulative operation time of all units will be reset.

The icon  is scheduled to appear after a certain duration of operation, based on the premise that the indoor units are installed in a space with ordinary air quality. Depending on the air quality, the filter may require more frequent cleaning.

The cumulative time at which filter needs cleaning depends on the model.

- This indication is not available for wireless remote controller.

⚠ Caution:

- Ask authorized people to clean the filter.

► Cleaning the filters

- Clean the filters using a vacuum cleaner. If you do not have a vacuum cleaner, tap the filters against a solid object to knock off dirt and dust.
- If the filters are especially dirty, wash them in lukewarm water. Take care to rinse off any detergent thoroughly and allow the filters to dry completely before putting them back into the unit.

⚠ Caution:

- Do not dry the filters in direct sunlight or by using a heat source, such as an electric heater: this may warp them.
- Do not wash the filters in hot water (above 50°C), as this may warp them.
- Make sure that the air filters are always installed. Operating the unit without air filters can cause malfunction.

⚠ Caution:

- Before you start cleaning, stop operation and turn OFF the power supply.
- Indoor units are equipped with filters to remove the dust of sucked-in air. Clean the filters using the methods shown in the following sketches.

► Filter removal

⚠ Caution:



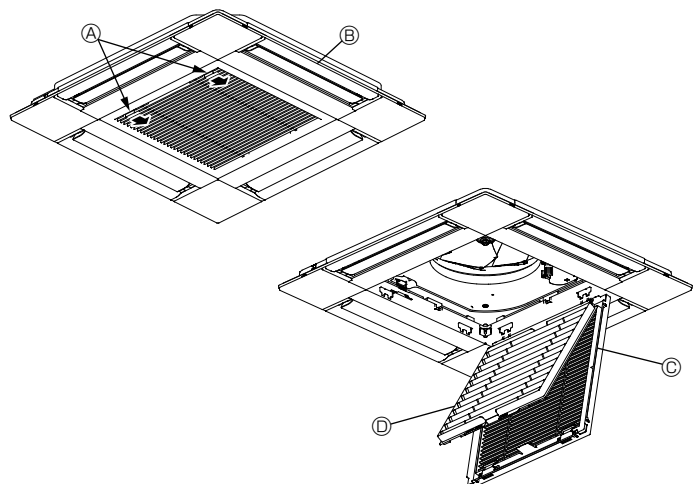

- In removing the filter, precautions must be taken to protect your eyes from dust. Also, if you have to climb up on a stool to do the job, be careful not to fall.
- When the filter is removed, do not touch the metallic parts inside the indoor unit, otherwise injury may result.

■ SLZ-KF-VA

- ① Slide the levers on the intake grille in the direction indicated by the arrow and it should open.
 - ② Open the intake grille.
 - ③ Release the knob on the center edge of the intake grille and pull the filter forward to remove the filter.
- Ⓐ Intake grille levers Ⓑ Grille Ⓒ Intake grille Ⓓ Filter



6. Trouble Shooting

Having trouble?	Here is the solution. (Unit is operating normally.)
Air conditioner does not heat or cool well.	<ul style="list-style-type: none"> ■ Clean the filter. (Airflow is reduced when the filter is dirty or clogged.) ■ Check the temperature adjustment and adjust the set temperature. ■ Make sure that there is plenty of space around the outdoor unit. Is the indoor unit air intake or outlet blocked? ■ Has a door or window been left open?
When heating operation starts, warm air does not blow from the indoor unit soon.	<ul style="list-style-type: none"> ■ Warm air does not blow until the indoor unit has sufficiently warmed up.
During heating mode, the air conditioner stops before the set room temperature is reached.	<ul style="list-style-type: none"> ■ When the outdoor temperature is low and the humidity is high, frost may form on the outdoor unit. If this occurs, the outdoor unit performs a defrosting operation. Normal operation should begin after approximately 10 minutes.
During cooling mode, the air conditioner stops when the set room temperature is reached.	<ul style="list-style-type: none"> ■ For SLZ-KF-VA series, when the set room temperature is reached during cooling mode, the fan operates at the lowest speed.
Airflow direction changes during operation or airflow direction cannot be set.	<ul style="list-style-type: none"> ■ During heating mode, the vanes automatically move to the horizontal airflow direction when the airflow temperature is low or during defrosting mode.
When the airflow direction is changed, the vanes always move up and down past the set position before finally stopping at the position.	<ul style="list-style-type: none"> ■ When the airflow direction is changed, the vanes move to the set position after detecting the base position.
A flowing water sound or occasional hissing sound is heard.	<ul style="list-style-type: none"> ■ These sounds can be heard when refrigerant is flowing in the air conditioner or when the refrigerant flow is changing.
A cracking or creaking sound is heard.	<ul style="list-style-type: none"> ■ These sounds can be heard when parts rub against each other due to expansion and contraction from temperature changes.
The room has an unpleasant odor.	<ul style="list-style-type: none"> ■ The indoor unit draws in air that contains gases produced from the walls, carpeting, and furniture as well as odors trapped in clothing, and then blows this air back into the room.
A white mist or vapor is emitted from the indoor unit.	<ul style="list-style-type: none"> ■ If the indoor temperature and the humidity are high, this condition may occur when operation starts. ■ During defrosting mode, cool airflow may blow down and appear like a mist.
Water or vapor is emitted from the outdoor unit.	<ul style="list-style-type: none"> ■ During cooling mode, water may form and drip from the cool pipes and joints. ■ During heating mode, water may form and drip from the heat exchanger. ■ During defrosting mode, water on the heat exchanger evaporates and water vapor may be emitted.
"  " appears in the remote controller display.	<ul style="list-style-type: none"> ■ During central control, "" appears in the remote controller display and air conditioner operation cannot be started or stopped using the remote controller.
When restarting the air conditioner soon after stopping it, it does not operate even though the ON/OFF button is pressed.	<ul style="list-style-type: none"> ■ Wait approximately three minutes. (Operation has stopped to protect the air conditioner.)
Air conditioner operates without the ON/OFF button being pressed.	<ul style="list-style-type: none"> ■ Is the on timer set? Press the ON/OFF button to stop operation. ■ Is the air conditioner connected to a central remote controller? Consult the concerned people who control the air conditioner. ■ Does "" appear in the remote controller display? Consult the concerned people who control the air conditioner. ■ Has the auto recovery feature from power failures been set? Press the ON/OFF button to stop operation.
Air conditioner stops without the ON/OFF button being pressed.	<ul style="list-style-type: none"> ■ Is the off timer set? Press the ON/OFF button to restart operation. ■ Is the air conditioner connected to a central remote controller? Consult the concerned people who control the air conditioner. ■ Does "" appear in the remote controller display? Consult the concerned people who control the air conditioner.
Remote controller timer operation cannot be set.	<ul style="list-style-type: none"> ■ Are timer settings invalid? If the timer can be set,  or  appears in the remote controller display.
"PLEASE WAIT" appears in the remote controller display.	<ul style="list-style-type: none"> ■ The initial settings are being performed. Wait approximately 3 minutes.
An error code appears in the remote controller display.	<ul style="list-style-type: none"> ■ The protection devices have operated to protect the air conditioner. ■ Do not attempt to repair this equipment by yourself. Turn off the power switch immediately and consult your dealer. Be sure to provide the dealer with the model name and information that appeared in the remote controller display.
Draining water or motor rotation sound is heard.	<ul style="list-style-type: none"> ■ When cooling operation stops, the drain pump operates and then stops. Wait approximately 3 minutes.
The vanes do not move or the indoor unit does not respond to input from the wireless remote controller.	<ul style="list-style-type: none"> ■ The junction wire connectors of the vane motor and signal receiver may not be connected correctly. Have an installer check the connections. (The colors of the male and female sections of the junction wire connectors must match.)

6. Trouble Shooting

Having trouble?	Here is the solution. (Unit is operating normally.)												
Noise is louder than specifications.	<p>■ The indoor operation sound level is affected by the acoustics of the particular room as shown in the following table and will be higher than the noise specification, which was measured in an echo-free room.</p> <table border="1"> <thead> <tr> <th></th> <th>High sound-absorbing rooms</th> <th>Normal rooms</th> <th>Low sound-absorbing rooms</th> </tr> </thead> <tbody> <tr> <td>Location examples</td> <td>Broadcasting studio, music room, etc.</td> <td>Reception room, hotel lobby, etc.</td> <td>Office, hotel room</td> </tr> <tr> <td>Noise levels</td> <td>3 to 7 dB</td> <td>6 to 10 dB</td> <td>9 to 13 dB</td> </tr> </tbody> </table>		High sound-absorbing rooms	Normal rooms	Low sound-absorbing rooms	Location examples	Broadcasting studio, music room, etc.	Reception room, hotel lobby, etc.	Office, hotel room	Noise levels	3 to 7 dB	6 to 10 dB	9 to 13 dB
	High sound-absorbing rooms	Normal rooms	Low sound-absorbing rooms										
Location examples	Broadcasting studio, music room, etc.	Reception room, hotel lobby, etc.	Office, hotel room										
Noise levels	3 to 7 dB	6 to 10 dB	9 to 13 dB										
Nothing appears in the wireless remote controller display, the display is faint, or signals are not received by the indoor unit unless the remote controller is close.	<p>■ The batteries are low. Replace the batteries and press the Reset button.</p> <p>■ If nothing appears even after the batteries are replaced, make sure that the batteries are installed in the correct directions (+, -).</p>												
The operation lamp near the receiver for the wireless remote controller on the indoor unit is flashing.	<p>■ The self diagnosis function has operated to protect the air conditioner.</p> <p>■ Do not attempt to repair this equipment by yourself. Turn off the power switch immediately and consult your dealer. Be sure to provide the dealer with the model name.</p>												

7. Installation, relocation and inspection

Installation place

Avoid installing the air conditioner in the following places.

- Where flammable gas could leak.

⚠ Caution:

Do not install the unit where flammable gas could leak. If gas leaks and collects around the unit, it may cause an explosion.

- Where there is much machine oil.
- Salty place such as the seaside.
- Where sulfide gas is generated such as a hot spring.
- Where there is oil splashing or much oily smoke.

⚠ Warning:

If the air conditioner operates but does not cool or heat (depending on model) the room, consult your dealer since there may be a refrigerant leak. Be sure to ask the service representative whether there is refrigerant leakage or not when repairs are carried out.

The refrigerant charged in the air conditioner is safe. Refrigerant normally does not leak, however, if refrigerant gas leaks indoors, and comes into contact with the fire of a fan heater, space heater, stove, etc., harmful substances will be generated.

Electrical work

- Provide an exclusive circuit for power supply of the air conditioner.
- Be sure to observe the breaker capacity.

⚠ Warning:

- **The customer should not install this unit. If the unit is installed incorrectly, fire, electric shock, injury due to a falling unit, water leakage, etc. may result.**
- **Do not connect using branched outlet or an extension cord, and do not attach many loads to one electric outlet. A fire or electric shock may result from poor contact, poor insulation, exceeding the permissible current, etc. Consult your dealer.**

⚠ Caution:

- **Apply grounding**
Do not connect a grounding wire to a gas pipe, water pipe, lightning rod or ground wire of a telephone.
If a grounding is incorrect, it may cause an electric shock.
- **Install an earth leakage breaker depending on the place where the air conditioner is to be installed (humid place, etc.).**
If the earth leakage breaker is not installed, it may cause an electric shock.

Inspection and maintenance

- When the air conditioner is used for several seasons, the capacity may be lowered due to dirt inside the unit.
- Depending upon the conditions of use, an odor may be generated or dirt, dust, etc. may prevent proper drainage.
- It is recommended to apply inspection and maintenance (charged) by a specialist in addition to normal maintenance. Consult your dealer.

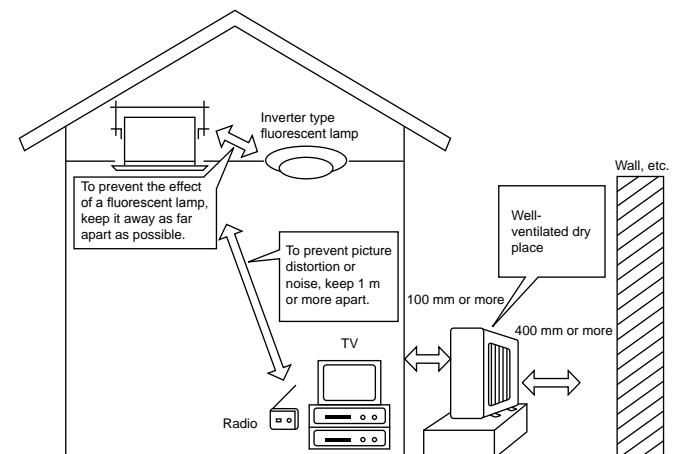

7. Installation, relocation and inspection

Also consider operation sound

- Do not put an object around the air outlet of the outdoor unit. It may cause lowering of capacity or increase operating sound.
- If abnormal sound is heard during operation, consult your dealer.

Relocation

- When the air conditioner is to be removed or reinstalled because of rebuilding, moving, etc., special techniques and work are required.

⚠ Warning:

Repair or relocation should not be done by the customer.

If this is done incorrectly, it may cause a fire, electric shock, injury by dropping of the unit, water leakage, etc. Consult your dealer.

Disposal

- To dispose of this product, consult your dealer.

If you have any question, consult your dealer.

8. Specifications

Model	SLZ-KF25VA	SLZ-KF35VA	SLZ-KF50VA	SLZ-KF60VA
Power Supply (Voltage <V>, Frequency <Hz>)	~N, 230V, 50Hz			
Rated Input (Indoor only) <kW>	0.02	0.02	0.03	0.04
Rated Current (Indoor only) <A>	0.20	0.24	0.32	0.43
Dimension (Height) <mm>	245 (10)			
Dimension (Width) <mm>	570 (625)			
Dimension (Depth) <mm>	570 (625)			
Fan airflow rate (Low-Middle-High) <m ³ /min>	6.5 - 7.5 - 8.5	6.5 - 8.0 - 9.5	7.0 - 9.0 - 11.5	7.5 - 11.5 - 13.0
Noise level (Low-Middle-High) <dB>	25 - 28 - 31	25 - 30 - 34	27 - 34 - 39	32 - 40 - 43
Net weight <kg>	15 (3)			

- Notes:** 1. This figure () indicates GRILLE's.
2. Specifications subject to change without notice.

Guaranteed operating range

		Indoor	Outdoor
Cooling	Upper limit	32°C DB, 23°C WB	46°C DB, –
	Lower limit	21°C DB, 15°C WB	-10°C DB, – / -15°C DB, – *1
Heating	Upper limit	27°C DB, –	24°C DB, 18°C WB
	Lower limit	20°C DB, –	-10°C DB, -11°C WB

*1 Depend on outdoor unit.

Units should be installed by licensed electric contractor accordingly to local code requirement.

EC DECLARATION OF CONFORMITY
EG-KONFORMITÄTSEKTLÄRUNG
DÉCLARATION DE CONFORMITÉ CE
EG-CONFORMITEITSVERKLARING

DECLARACIÓN DE CONFORMIDAD CE
DICHIARAZIONE DI CONFORMITÀ CE
ΔΗΛΩΣΗ ΠΙΣΤΟΤΗΤΑΣ ΕΚ

DECLARAÇÃO DE CONFORMIDADE CE
EU-OVERENSSTEMMELSESEKTLÆRING
EG-DEKLARATION OM ÖVERENSSTÄMMELSE

EC UYGUNLUK BEYANI
ДЕКЛАРАЦИЯ СООТВЕТСТВИЯ НОРМАМ ЕС

MITSUBISHI ELECTRIC CORPORATION, SHIZUOKA WORKS
18-1, OSHIKA 3-CHOME, SURUGA-KU, SHIZUOKA-CITY 422-8528, JAPAN

hereby declares under its sole responsibility that the air conditioners and heat pumps described below for use in residential, commercial and light-industrial environments:
erklärt hiermit auf seine alleinige Verantwortung, dass die Klimaanlageanlagen und Wärmepumpen für das häusliche, kommerzielle und leicht-industrielle Umfeld wie unten beschrieben:
déclare par la présente et sous sa propre responsabilité que les climatiseurs et les pompes à chaleur décrits ci-dessous, destinés à un usage dans des environnements résidentiels, commerciaux et d'industrie légère :
verklaart hierbij onder eigen verantwoordelijkheid dat de voor residentiële, commerciële en licht-industriële omgevingen bestemde airconditioners en warmtepompen zoals onderstaand beschreven:
por la presente declara bajo su única responsabilidad que los acondicionadores de aire y bombas de calor descritas a continuación para su uso en entornos residenciales, comerciales y de industria ligera:
conferma con la presente, sotto la sua esclusiva responsabilità, che i condizionatori d'aria e le pompe di calore descritti di seguito e destinati all'utilizzo in ambienti residenziali, commerciali e semi-industriali:
με το παρόν πιστοποιεί με αποκλειστική της ευθύνη ότι οι τα κλιματιστικά και οι αντλίες θέρμανσης που περιγράφονται παρακάτω για χρήση σε οικιακό, επαγγελματικό και ελαφριάς βιομηχανίας περιβάλλοντα:
através da presente declara sob sua única responsabilidade que os aparelhos de ar condicionado e bombas de calor abaixo descritos para uso residencial, comercial e de indústria ligeira:
erklærer hermed under eneansvar, at de herunder beskrevne airconditionanlæg og varmepumper til brug i privat boligbyggeri, erhvervsområder og inden for let industri:
intyggar härmed att luftkonditioneringarna och värmepumparna som beskrivs nedan för användning i bostäder, kommersiella miljöer och lätta industriella miljöer:
ev, ticaret ve hafif sanayi ortamlarında kullanım amaçlı üretilen ve aşağıda açıklanan klima ve ısıtma pompalarıyla ilgili aşağıdaki hususları yalnızca kendi sorumluluğunda beyan eder:
настоящим заявляет и берет на себя исключительную ответственность за то, что кондиционеры и тепловые насосы, описанные ниже и предназначенные для эксплуатации в жилых помещениях, торговых залах и на предприятиях легкой промышленности:

MITSUBISHI ELECTRIC, SLZ-KF25VA*, SLZ-KF35VA*, SLZ-KF50VA*, SLZ-KF60VA*

Note: Its serial number is on the nameplate of the product.
Hinweis: Die Seriennummer befindet sich auf dem Kennschild des Produkts.
Remarque : Le numéro de série de l'appareil se trouve sur la plaque du produit.
Opmerking: het serienummer staat op het naamplaatje van het product.
Nota: El número de serie se encuentra en la placa que contiene el nombre del producto.
Nota: il numero di serie si trova sulla targhetta del prodotto.

Σημείωση: Ο σειριακός του αριθμός βρίσκεται στην πινακίδα ονόματος του προϊόντος.
Nota: o número de série encontra-se na placa que contém o nome do produto.
Bemærk: Serienummeret står på produktets fabriksskilt.
Obs: Serienumret finns på produktens namnplåt.
Not: Seri numarasi ürünün isim plakasında yer alır.
Примечание: серийный номер указан на паспортное табличке изделия.

Directives
Richtlijnen
Directives
Richtlijnen
Directivas
Direttive
Οδηγίες
Directivas
Direktiver
Direktiv
Direktifler
Директивы

2006/95/EC: Low Voltage
2006/42/EC: Machinery
2004/108/EC: Electromagnetic Compatibility
2009/125/EC: Energy-related Products

Our authorized representative in EU, who is authorized to compile the technical file, is as follows.
Unser autorisierter Vertreter in der EU, der ermächtigt ist die technischen Daten zu kompilieren, ist wie folgt.
Notre représentant agréée dans L'UE, qui est autorisé à compiler le fichier technique, est le suivant.
Onze geautoriseerde vertegenwoordiger in de EU, die gemachtigd is het technische bestand te compileren, is als volgt.
Nuestro representante autorizado en la UE, que está autorizado para compilar el archivo técnico, es el siguiente.
Il nostro rivenditore autorizzato nell'UE, responsabile della stesura della scheda tecnica, è il seguente.

Ο εξουσιοδοτημένος αντιπρόσωπός μας στην ΕΕ, ο οποίος είναι εξουσιοδοτημένος να συντάξει τον τεχνικό φάκελο, είναι ο εξής.
O nosso representante autorizado na UE, que está autorizado para compilar o ficheiro técnico, é o seguinte:
Vores autoriserede repræsentant i EU, som er autoriseret til udarbejdelse af den tekniske fil, er følgende.
Vår EG-representant som är auktoriserad att sammanställa den tekniska filen är följande.
Avrupa Birliği'nde bulunan ve teknik dosyayı düzenleme yetkisine sahip yetkili temsilcimiz aşağıda belirtilmiştir:
Наш авторизованный представитель в ЕС, уполномоченный на составление технического файла, указан ниже.

MITSUBISHI ELECTRIC EUROPE, B.V.
HARMAN HOUSE, 1 GEORGE STREET, UXBRIDGE, MIDDLESEX UB8 1QQ, U.K.
Masahiko KONISHI
Product Marketing Director

Issued:
THAILAND

6, June, 2015

Tomoyuki MIWA
Manager, Quality Assurance Department

Revised date:

THAILAND

<ENGLISH>

English is original. The other languages versions are translation of the original.

⚠ CAUTION

- Refrigerant leakage may cause suffocation. Provide ventilation in accordance with EN378-1.
- Be sure to wrap insulation around the piping. Direct contact with the bare piping may result in burns or frostbite.
- Never put batteries in your mouth for any reason to avoid accidental ingestion.
- Battery ingestion may cause choking and/or poisoning.
- Install the unit on a rigid structure to prevent excessive operation sound or vibration.
- Noise measurement is carried out in accordance with JIS C9612, JIS B8616, ISO 5151(T1), and ISO 13523(T1).

<DEUTSCH>

Das Original ist in Englisch. Die anderen Sprachversionen sind vom Original übersetzt.

⚠ VORSICHT

- Das Auslaufen von Kältemittel kann zu Erstickung führen. Sorgen Sie für Belüftung gemäß der Bestimmung EN378-1.
- Sicherstellen, dass die Rohrführung isoliert ist. Direkter Kontakt mit der blanken Rohrleitung kann zu Verbrennungen oder Erfrierungen führen.
- Nehmen Sie unter keinen Umständen Batterien in den Mund, um versehentliches Verschlucken zu vermeiden.
- Das Verschlucken von Batterien kann zu Erstickung und/oder Vergiftung führen.
- Installieren Sie das Gerät an einer stabilen Struktur, um übermäßige Betriebsgeräusche oder Vibration zu vermeiden.
- Geräuschmessungen werden gemäß der Bestimmungen JIS C9612, JIS B8616, ISO 5151(T1), und ISO 13523(T1) ausgeführt.

<FRANÇAIS>

L'anglais est l'original. Les versions fournies dans d'autres langues sont des traductions de l'original.

⚠ PRECAUTION

- Une fuite de réfrigérant peut entraîner une asphyxie. Fournissez une ventilation adéquate en accord avec la norme EN378-1.
- Assurez-vous que la tuyauterie est enveloppée d'isolant. Un contact direct avec la tuyauterie nue peut entraîner des brûlures ou des engelures.
- Ne mettez jamais des piles dans la bouche pour quelque raison que ce soit pour éviter de les avaler par accident.
- Le fait d'ingérer des piles peut entraîner un étouffement et/ou un empoisonnement.
- Installez l'unité sur une structure rigide pour prévenir un bruit de fonctionnement et une vibration excessifs.
- Les mesures de niveau sonore ont été effectuées en accord avec les normes JIS C9612, JIS B8616, ISO 5151(T1) et ISO 13523(T1).

<NEDERLANDS>

Het Engels is het origineel. De andere taalversies zijn vertalingen van het origineel.

⚠ VOORZICHTIG

- Het lekken van koelvloeistof kan verstikking veroorzaken. Zorg voor ventilatie in overeenstemming met EN378-1.
- isoleer de leidingen met isolatiemateriaal. Direct contact met de onbedekte leidingen kan leiden tot brandwonden of bevriezing.
- Stop nooit batterijen in uw mond om inslikking te voorkomen.
- Het inslikken van batterijen kan verstikking of vergiftiging veroorzaken.
- Installeer het apparaat op een stabiele structuur om overmatig lawaai of trillingen te voorkomen.
- Geluidsmetingen worden uitgevoerd in overeenstemming met JIS C9612, JIS B8616, ISO 5151(T1), en ISO 13523(T1).

<ESPAÑOL>

El idioma original del documento es el inglés. Las versiones en los demás idiomas son traducciones del original.

⚠ CUIDADO

- Las pérdidas de refrigerante pueden causar asfixia. Se debe proporcionar la ventilación determinada en EN378-1.
- Asegúrese de colocar el aislante alrededor de las tuberías. El contacto directo con la tubería puede ocasionar quemaduras o congelación.
- Para evitar una ingestión accidental, no coloque las pilas en su boca bajo ningún concepto.
- La ingestión de las pilas puede causar asfixia y/o envenenamiento.
- Coloque la unidad en una estructura rígida para evitar que se produzcan sonidos o vibraciones excesivos debidos a su funcionamiento.
- La medición de los ruidos se lleva a cabo de acuerdo con JIS C9612, JIS B8616, ISO 5151(T1) y ISO 13523(T1).

<ITALIANO>

Il testo originale è redatto in lingua Inglese. Le altre versioni linguistiche rappresentano traduzioni dell'originale.

⚠ ATTENZIONE

- Perdite di refrigerante possono causare asfissia. Prevedere una ventilazione adeguata in conformità alla norma EN378-1.
- Accertarsi di applicare materiale isolante intorno alle tubature. Il contatto diretto con le tubature non schermate può provocare ustioni o congelamento.
- Non introdurre in nessun caso le batterie nella bocca onde evitare ingestioni accidentali.
- L'ingestione delle batterie può provocare soffocamento e/o avvelenamento.
- Installare l'unità su di una struttura rigida in modo da evitare rumore o vibrazioni eccessivi durante il funzionamento.
- La misurazione del rumore viene effettuata in conformità agli standard JIS C9612, JIS B8616, ISO 5151(T1) e ISO 13523(T1).

<ΕΛΛΗΝΙΚΑ>

Η γλώσσα του πρωτοτύπου είναι η αγγλική. Οι εκδόσεις άλλων γλωσσών είναι μεταφράσεις του πρωτοτύπου.

⚠ ΠΡΟΣΟΧΗ

- Η διαρροή του ψυκτικού ενδέχεται να προκαλέσει ασφυξία. Φροντίστε για τον εξαερισμό σύμφωνα με το EN378-1.
- Βεβαιωθείτε ότι τυλίξατε με μονωτικό υλικό τη σωλήνωση. Η απευθείας επαφή με τη γυμνή σωλήνωση ενδέχεται να προκαλέσει εγκαύματα ή κρυοπαγήματα.
- Μην βάζετε ποτέ τις μπαταρίες στο στόμα σας για κανένα λόγο ώστε να αποφύγετε την κατά λάθος κατάποσή τους.
- Η κατάποση μπαταριών ενδέχεται να προκαλέσει πνιγμό και/ή δηλητηρίαση.
- Εγκαταστήστε τη μονάδα σε σταθερή κατασκευή ώστε να αποφύγετε τον έντονο ήχο λειτουργίας ή τους κραδασμούς.
- Η μέτρηση θορύβου πραγματοποιήθηκε σύμφωνα με τα JIS C9612, JIS B8616, ISO 5151(T1) και ISO 13523(T1).

<PORTUGUÊS>

O idioma original é o inglês. As versões em outros idiomas são traduções do idioma original.

⚠ CUIDADO

- As fugas de refrigerante podem provocar asfixia. Proporcione ventilação de acordo com a EN378-1.
- Certifique-se de que coloca isolamento em redor da tubagem. O contacto directo com a tubagem pode resultar em queimaduras ou úlceras causadas pelo frio.
- Para evitar uma ingestão acidental, nunca coloque pilhas na boca.
- A ingestão das pilhas pode provocar asfixia e/ou envenenamento.
- Instale a unidade numa estrutura rígida para evitar vibrações ou ruídos excessivos durante o seu funcionamento.
- A medição dos ruídos é efectuada de acordo com a JIS C9612, JIS B8616, ISO 5151(T1), e ISO 13523(T1).

<DANSK>

Engelsk er originalen. De andre sprogversioner er oversættelser af originalen.

⚠ FORSIGTIG

- Kølemiddellækage kan forårsage kvælning. Sørg for ventilation i henhold til EN378-1.
- Der skal altid vikles isolering omkring rørene. Direkte kontakt med blottagte rør kan medføre forbrænding eller forfrysning.
- Put aldrig batterier i munden uanset årsag, du kan komme til at sluge dem.
- Hvis batterier sluges, kan det medføre kvælning og/eller forgiftning.
- Monter enheden på en fast struktur, så kraftig lyd og vibration undgås.
- Støjmåling udføres i henhold til JIS C9612, JIS B8616, ISO 5151(T1) og ISO 13523(T1).

<SVENSKA>

Engelska är originalspråket. De övriga språkversionerna är översättningar av originalet.

⚠ FÖRSIKTIGHET

- Köldmedelsläckage kan leda till kvävning. Tillhandahåll ventilation i enlighet med EN378-1.
- Kom ihåg att linda isolering runt rören. Direktkontakt med bara rör kan leda till brännskador eller köldskador.
- Stoppa aldrig batterier i munnen, de kan sväljas av misstag.
- Om ett batteri sväljs kan det leda till kvävning och/eller förgiftning.
- Montera enheten på ett stadigt underlag för att förhindra höga driftljud och vibrationer.
- Ljudmätningar har utförts i enlighet med JIS C9612, JIS B8616, ISO 5151(T1) och ISO 13523(T1).

<TÜRKÇE>

Aslı İngilizce'dir. Diğer dillerdeki sürümler aslının çevirisidir.

⚠ DİKKAT

- Soğutucu sızıntısı boğulma tehlikesine yol açabilir. EN378-1'e göre havalandırma sağlayın.
- Boruların etrafına izolasyon malzemesi kaplamayı unutmayın. Çıplak boruya doğrudan temas etmek yanmaya ve soğuk ısırmasına neden olabilir.
- Yanlışlıkla yutmamak için pilleri hiçbir nedenle asla ağzınıza sokmayın.
- Pili yutmak boğulmaya ve/veya zehirlenmeye neden olabilir.
- Aşırı çalışma sesinin veya titreşimin oluşmaması için üniteyi sert bir yapı üzerine kurun.
- Ses ölçümü JIS C9612, JIS B8616, ISO 5151(T1), ve ISO 13523(T1) standartlarına göre yapılır.

<РУССКИЙ>

Языком оригинала является английский. Версии на других языках являются переводом оригинала.

⚠ ОСТОРОЖНО

- Утечка хладагента может стать причиной удущья. Обеспечьте вентиляцию в соответствии с EN378-1.
- Обязательно оберните трубы изоляционной обмоткой. Непосредственный контакт с неизолированным трубопроводом может привести к ожогам или обморожению.
- Запрещается класть элементы питания в рот по каким бы то ни было причинам во избежание случайного проглатывания.
- Попадание элемента питания в пищеварительную систему может стать причиной удущья и/или отравления.
- Устанавливайте устройство на жесткую структуру во избежание чрезмерного шума или чрезмерной вибрации во время работы.
- Измерение шума выполняется в соответствии с JIS C9612, JIS B8616, ISO 5151(T1) и ISO 13523(T1).

Please be sure to put the contact address/telephone number on
this manual before handing it to the customer.

Не забудьте указать контактный адрес/номер телефона в
данном руководстве, прежде чем передать его клиенту.



mitsubishi electric corporation

HEAD OFFICE: TOKYO BLDG., 2-7-3, MARUNOUCHI, CHIYODA-KU, TOKYO 100-8310, JAPAN
Authorized representative in EU: MITSUBISHI EUROPE.B.V HARMAN HOUSE, 1 GEORGE STREET,
UXBRIDGE, MIDDLESEX UB8 1QQ.U.K.

Название Компании: ООО «Мицубиси Электрик (РУС)»

Адрес: россия, 115054, Москва, Космодамианская наб., д. 52, стр. 1